

KBB SET KATALOĐU

ENT SET CATALOGUE



www.karaoglucerrahi.com.tr

 **KARAOĐLU**[®]

KBB SET KATALOĐU

ENT SET CATALOGUE

 **KARAOĐLU**[®]



KARAOĐLU CERRAHİ ALETLER
İstiklal Mah. İlkadım Sanayi Sitesi 58.Sok. No:77
TEKKEKÖY/SAMSUN
Tel : 0555 013 61 05 - (0362) 238 61 04 - Fax : (0362) 238 55 91

info@karaoglcerrahi.com.tr

www.karaoglcerrahi.com.tr



HAKKIMIZDA

KARAOĞLU, sağlık sektöründe hizmet veren bir aile şirkettir. 1955 yılında babamız Ali Karaoğlu'nun demir dövme ve sıcak demir atölyesi ile temelleri atılan KARAOĞLU, 1994 yılında Türkiye'nin cerrahi alet sektöründe duyduğu ihtiyaca cevap vermek için kurulmuştur. Geçmişten gelen bilgi ve deneyimi, sektörün ihtiyaç duyduğu AR-GE çalışmaları ve teknolojideki gelişmeler ile birleştirip insan sağlığı için üretmeye devam ediyoruz.

ABOUT US

KARAOGLU is a family company serving in the health sector. Founded in 1955 by our father Ali Karaoğlu as a forging and blacksmith shop, KARAOGLU was established in 1994 to meet the needs of Turkey in the surgical instrument sector. We continue to produce for human health by combining the knowledge and experience from the past with the R&D studies and technological developments needed by the industry.



www.karaoglucerrahi.com.tr



MİSYON

Misyonumuz; tecrübe ve bilgiyi, teknolojik gelişmeler ile harmanlayarak sağlık sektöründe büyümek ve sürekli değişen ve gelişen dünyada sektörün lider ve kalıcı firmalarından olmaya devam etmektir. Aynı zamanda bir okul gibi yeni nesilleri eğiterek, hem mesleki gelişimlerine katkı sağlıyor hem de ülkemize karşı sorumluluğumuzu yerine getiriyoruz.

MISSION

Our mission; To grow in the health sector by blending experience and knowledge with technological developments and to continue to be one of the leading and permanent companies of the sector in the constantly changing and developing world. At the same time, by educating new generations like a school, we both contribute to their professional development and fulfill our responsibility towards our country.

ÜRETİM

Cerrahi alet ürünlerimiz uluslararası standartlarda üretilmiş olup, tüm branşların ihtiyacını karşılayabilecek çeşitliliğe sahiptir. Fabrikamızda genel cerrahi, jinekoloji, üroloji, beyin cerrahi, kalp damar cerrahi, KBB cerrahi, plastik cerrahi ve steril konteyner üretimi yapılmaktadır. Tüm ürünlerimiz modern üretim tekniklerine uygun olarak yüksek kalite Alman paslanmaz çelikten yapılmaktadır.

PRODUCTION

Our surgical instrument products are produced in international standards and have the variety to meet the needs of all branches. Our factory produces general surgery, gynecology, urology, neurosurgery, cardiovascular surgery, ENT surgery, plastic surgery and sterile containers instruments. All our products are made of high quality German stainless steel in accordance with modern production techniques.



www.karaoglugcerrahi.com.tr

GARANTİ

KARAOĞLU tescilli markasını ve logosunu taşıyan ürünler malzeme ve işçilik hatalarına karşı 2 yıl garantilidir. Bu periyod içinde, normal kullanım koşullarında arızalanan aletler ücretsiz olarak onarılacak ya da yenisi ile değiştirilecektir. Garanti kapsamı dışında kalan ürünler için bakım ve onarım yapılmaktadır.

GUARANTEE

Products bearing the KARAOĞLU registered trademark and logo are guaranteed for 2 years against material and workmanship defects. During this period, tools that fail under normal use will be repaired or replaced free of charge. Maintenance and repair are carried out for products out of warranty.



İÇİNDEKİLER / CONTENTS

Miringotomi Seti
Myringotomy Set

7-12

Kulak Mikrocerrahi Seti
Ear Microsurgery Set

13-24

Nasal Septum Cerrahi Seti
Nasal Septum Surgery Set

25-36

Rinoplasti Seti
Rhinoplasty Set

37-48

Tonsillektomi ve Adenoidektomi Seti
Tonsillectomy And Adenoidectomy Set

49-58

Trakeostomi Seti
Tracheostomy Set

59-70

Mikro Cerrahi Seti
Micro Surgery Set

71-78

Miringotomi Seti

Myringotomy Set



 **KARAOĞLU**[®]



| No | Quantity | Code | Description |
|----|----------|-----------------|---|
| 1 | 1 | KY107.01 | Toynbee Ear Speculum, 4.0 mm |
| 2 | 1 | KY107.02 | Toynbee Ear Speculum, 5.5 mm |
| 3 | 1 | KY107.04 | Toynbee Ear Speculum, 7.5 mm |
| 4 | 1 | KY246.16 | Politzer Knife, 16 cm |
| 5 | 1 | KB231.01 | Suction Canulla, Handle, Luer Cone |
| 6 | 1 | KB231.05 | Suction Canulla, Luer Cone, 0.5 mm |
| 7 | 1 | KB231.09 | Suction Canulla, Luer Cone, 0.9 mm |
| 8 | 1 | KB231.16 | Suction Canulla, Luer Cone, 1.6 mm |
| 9 | 1 | KY209.10 | Barbara Hook, 1 mm |
| 10 | 1 | KY234.01 | Buck Ear Curette, Curved, 2.5 mm, 15 cm |
| 11 | 1 | KY166.06 | Hartman-Wullstein Ear Forceps 8.5 cm |
| 12 | 1 | KC410.04 | Mini Container 300 X 140 X 40 mm |
| 13 | 1 | KC850.00 | Silicon Mat 270 X 125 mm |



1 2 3



4



5



6



7



8



9



10



11



12

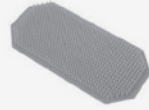

13

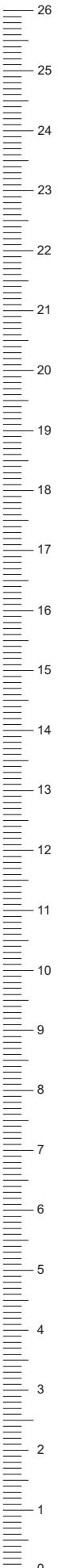



TOYNBEE
Paslanmaz çelik/Stainless Steel



KY107.01 Ø 4.0 mm
KY107.02 Ø 5.5 mm
KY107.04 Ø 7.5 mm



POLITZER
KY246.16
16 cm



Olive
Ø 6-8 mm
1/2

KB231.01 Sap/Handle
KB231.05 Ø 0.5 mm
KB231.09 Ø 0.9 mm
KB231.16 Ø 1.6 mm
LUER koniği/With LUER cone

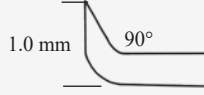

BARBARA
KY209.10
Düz şaft/Straight shaft
17.5 cm

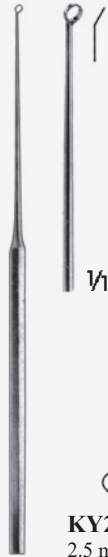

KY234.01
2.5 mm

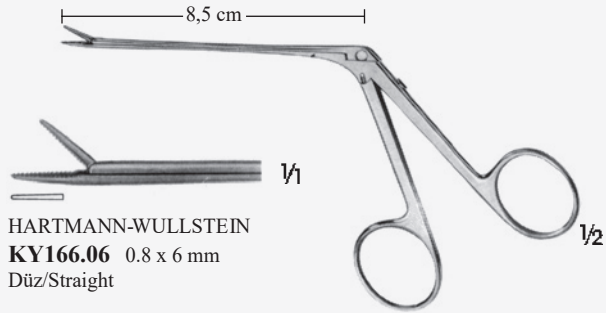

HARTMANN-WULLSTEIN
KY166.06 0.8 x 6 mm
Düz/Straight



STERILE CONTAINER
KC410.04
Mini Container
300 x 140 x 40 mm

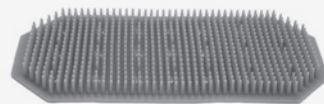

SILICONE MAT
KC850.00 For Sterile Container
Silicone Mat
270 x 125 mm



Kulak Mikrocerrahi Seti •

Ear Microsurgery Set

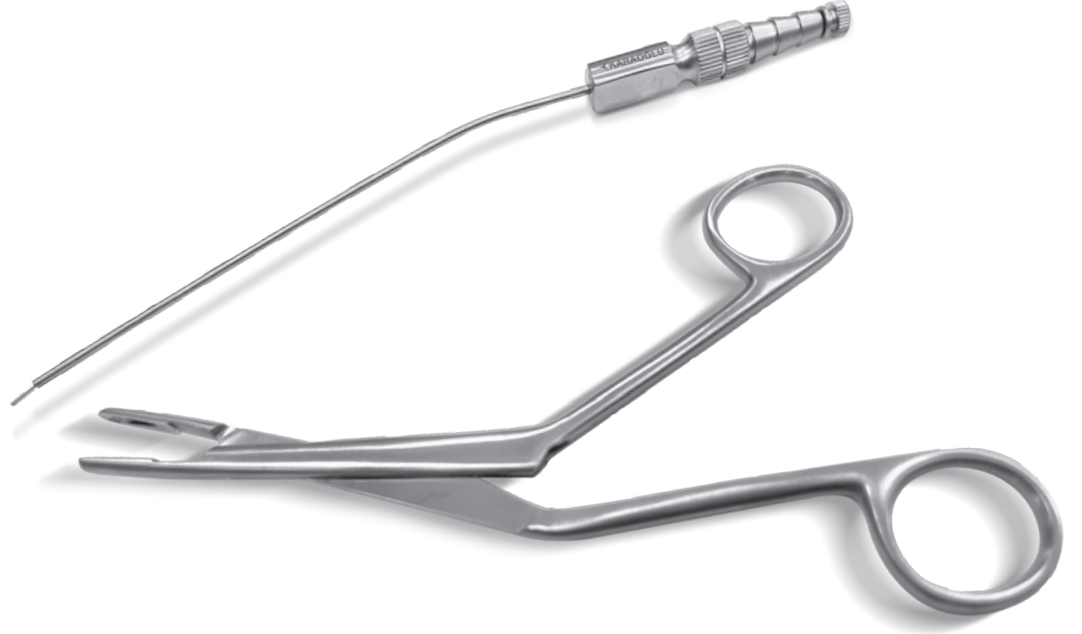

 **KARAOĞLU®**



| No | Quantity | Code | Description |
|----|----------|-----------------|--|
| 1 | 1 | KY107.01 | Tynbe Ear Speculum, Ø 4.0 mm |
| 2 | 1 | KY107.02 | Tynbe Ear Speculum, Ø 5.5 mm |
| 3 | 1 | KY107.04 | Tynbe Ear Speculum, Ø 7.5 mm |
| 4 | 2 | KA101.03 | Scalpel Handle, 3 No, 13.5 cm |
| 5 | 1 | KY204.03 | Plester Ear Knife 15 cm |
| 6 | 2 | KY205.20 | Plester Ear Knife, 16 cm |
| 7 | 2 | KY204.02 | Plester Ear Knife, 16 cm |
| 8 | 1 | KY170.06 | Shea Ear Scissors, 8 cm |
| 9 | 1 | KY170.02 | Belluci Ear Scissors, 8 cm |
| 10 | 1 | KE107.13 | Surgical Scissors, Curved, 13 cm |
| 11 | 1 | KE107.14 | Surgical Scissors, Curved, 14.5 cm |
| 12 | 1 | KE375.12 | Wire Scissors, Serrated, 12 cm |
| 13 | 1 | KD144.15 | Semken Forcep, 15 cm |
| 14 | 1 | KD115.13 | Tissue Forcep 13 cm |
| 15 | 6 | KG392.09 | Backhaus Towel Clamp, 9 cm |
| 16 | 1 | KF162.13 | Halsey Needle Holder, 13 cm |
| 17 | 1 | KG130.12 | Micro-Halsted Haemostatic Forceps, Straight, 12.5 cm |
| 18 | 2 | KG131.12 | Micro-Halsted Haemostatic Forceps, Curved, 12.5 cm |
| 19 | 1 | KG145.14 | Crille Haemostatic Forceps, Straight, 14 cm |
| 20 | 1 | KB110.15 | Plester Suction Tube, With Luer Hub, Ø 1.5 mm, 19.5 cm |
| 21 | 1 | KB110.20 | Plester Suction Tube, With Luer Hub, Ø 2.0 mm, 19.5 cm |
| 22 | 1 | KB110.25 | Plester Suction Tube, With Luer Hub, Ø 2.5 mm, 19.5 cm |
| 23 | 1 | KB231.01 | Suction Tube, Handle |
| 24 | 4 | KB231.05 | Suction Tube, With Luer Cone, Ø 0.5 mm |
| 25 | 4 | KB231.07 | Suction Tube, With Luer Cone, Ø 0.7 mm |
| 26 | 4 | KB231.09 | Suction Tube, With Luer Cone, Ø 0.9 mm |
| 27 | 4 | KB231.12 | Suction Tube, With Luer Cone, Ø 1.2 mm |
| 28 | 1 | KY209.03 | Barbara Ear Pick 16.5 cm, 0.3 mm |
| 29 | 1 | KY209.06 | Barbara Ear Pick, 0.6 mm, 16.5 cm |
| 30 | 1 | KY209.10 | Barbara Ear Pick, 1.0 mm, 16 cm |
| 31 | 1 | KY208.06 | Barbara Ear Pick, 45° |
| 32 | 1 | KY208.10 | Barbara Ear Hook 45° 1.0 mm |
| 33 | 2 | KY210.05 | Barbara Ear Hook 16 cm, 0.5 mm |
| 34 | 1 | KY212.10 | Ear Hook, 90°, 1.0 mm |
| 35 | 1 | KY238.00 | Williger Retractor, sharp, 12 cm |
| 36 | 1 | KY311.02 | Hartman-Halle Speculum 15.5 cm |
| 37 | 1 | KI106.11 | Bellucci Self-Retaining Retractor, Blunt Left, 11 cm |
| 38 | 1 | KI107.11 | Bellucci Self-Retaining Retractor, Blunt Right, 11 cm |
| 39 | 2 | KI109.13 | Plester Self-Retaining Retractor, Blunt, 13 cm |
| 40 | 2 | KY392.18 | Halle Elevator, Blunt, 3.3 mm 18 cm |
| 41 | 1 | KY217.06 | Schuknecht Ear Spatula 15.5 cm, 0.6 mm |
| 42 | 1 | KJ122.16 | Williger Raspatory 6 mm, 16 cm |
| 43 | 2 | KY224.10 | Hause Ear Curette 18 cm, 1.0 mm / 1.2 mm |
| 44 | 2 | KY225.10 | Hause-Type Ear Curette 16 cm, 1.5 mm / 1.8 mm |
| 45 | 1 | KY235.10 | Buck Ear Hook 2.0 mm 15 cm |
| 46 | 1 | KY235.01 | Buck Ear Hook 2.5 mm 15 cm |
| 47 | 1 | KY167.01 | Hartmann-Wullstein Forcep, Ø 1 mm |
| 48 | 1 | KY167.02 | Hartmann-Wullstein Forcep, Ø 2 mm |
| 49 | 1 | KY166.06 | Hartmann-Wullstein Forcep, 0.8x6 mm |
| 50 | 1 | KY168.30 | Dieter Ear Forcep, 7 cm |
| 51 | 1 | KY168.12 | McGee Ear Forcep, 7 cm |
| 52 | 1 | KY128.12 | Schuknecht Vein Press |
| 53 | 1 | KY206.01 | Ear Perforator, 1 mm, 16 cm |
| 54 | 1 | KC310.13 | 1/2 Size Container 285x280x135 mm |
| 55 | 2 | KC390.05 | Wire Baskets, 255 x 245 x 50 mm |
| 56 | 1 | KC851.00 | Silicon Mat, 245 x 245 mm |
| 57 | 1 | KP202.00 | Bipolar Cord, 2 mt. |
| 58 | 1 | KP109.01 | Bipolar Forceps, insulated, 20 cm, 1.8 mm |

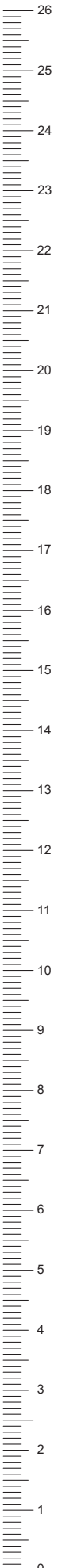
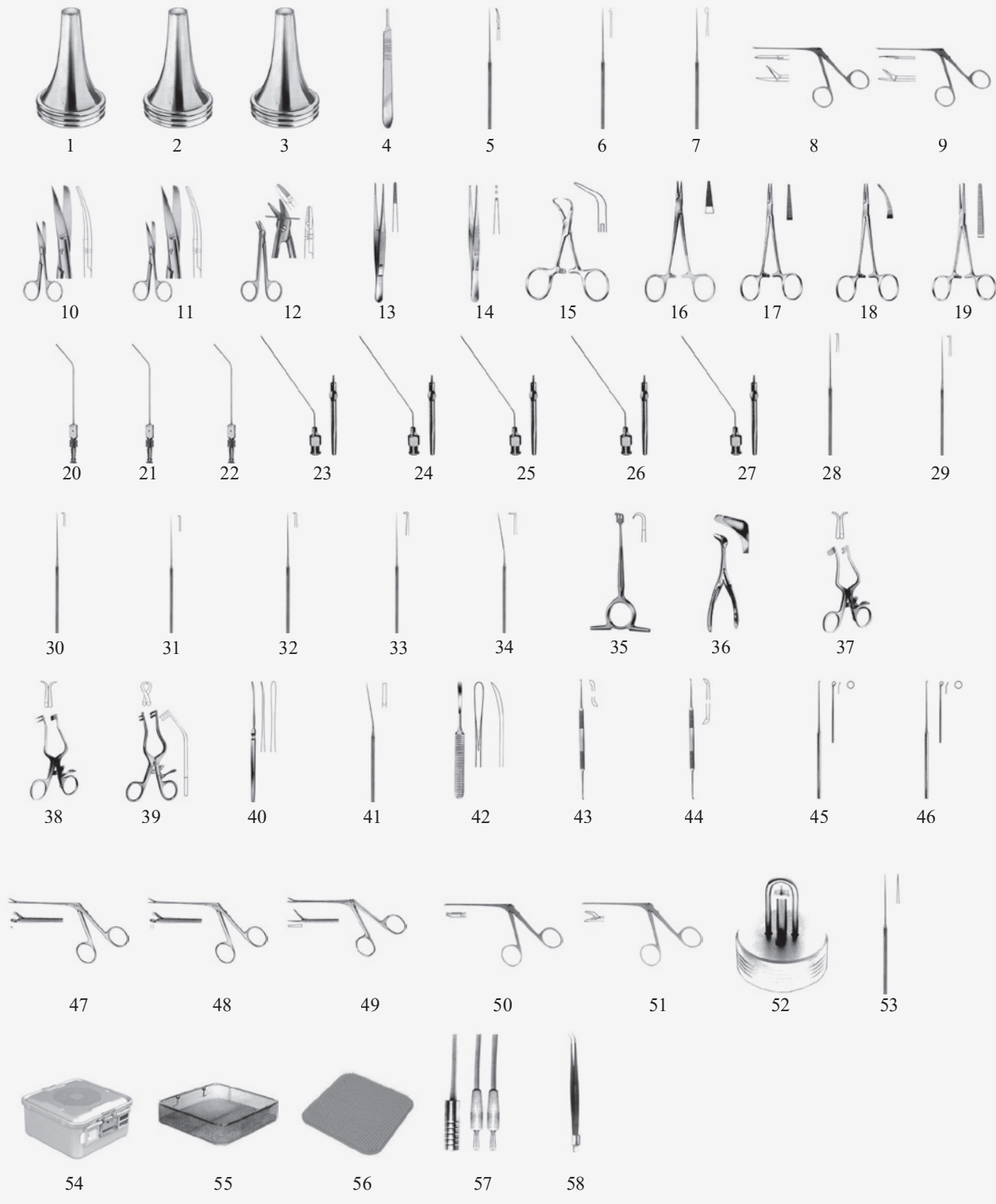



TOYNBEE
Paslanmaz çelik/Stainless Steel



KY107.01
Ø 4.0 mm



KY107.02
Ø 5.5 mm



KY107.04
Ø 7.5 mm



1/1
KA101.03
13.5 cm

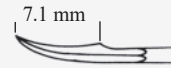

PLESTER
KY204.03
Düz şaft/Straight shaft
15 cm

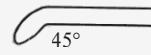
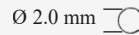

KY205.20
Düz şaft/Straight shaft
16 cm

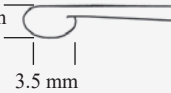

PLESTER
KY204.02
Düz şaft/Straight shaft
16 cm



SHEA
KY170.06
8 cm

BELLUCI
KY170.02
Düz şaft/Straight shaft
8 cm



Sivri/Künt, Eğri
Sharp/Blunt, Curved

KE107.13
13 cm

KE107.14
14.5 cm

1/2

KE375.12
Tek ağız tırtıllı
One jaw serrated
12 cm

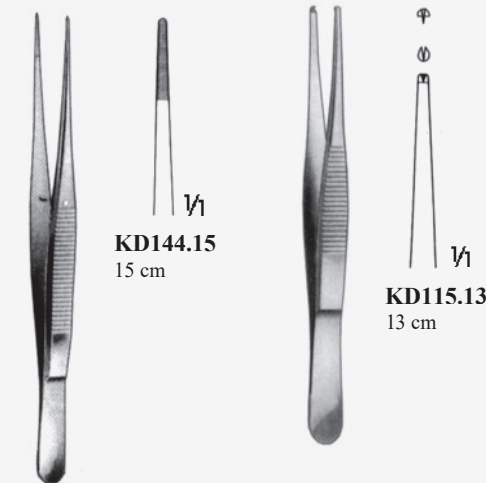

KD144.15
15 cm

KD115.13
13 cm

SEMKEN

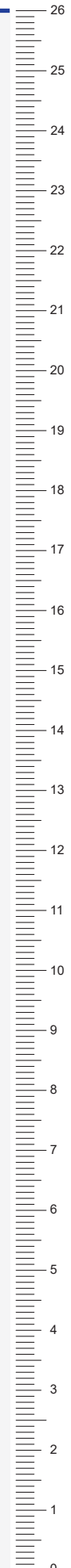



BACKHAUS



HALSEY
KF162.13
13 cm



1/2

MICRO-HALSTED
12.5 cm



1/2

CRILE
14 cm



Olive
Ø 6-9 mm

PLESTER
KB110.15 Ø 1.5 mm
KB110.20 Ø 2.0 mm
KB110.25 Ø 2.5 mm
LUER bağlantılı
With LUER hub
19.5 cm



Olive
Ø 6-8 mm

KB231.01 Sap/Handle
KB231.05 Ø 0.5 mm
KB231.07 Ø 0.7 mm
KB231.09 Ø 0.9 mm
KB231.12 Ø 1.2 mm
LUER koniği/With LUER cone



0.3 mm
BARBARA
KY209.03
Düz şaft/Straight shaft
16.5 cm

1.0 mm
BARBARA
KY209.10
Düz şaft/Straight shaft
16 cm

0.7 mm
BARBARA
KY209.06
Düz şaft/Straight shaft
16.5 cm

45° 0.5 mm
BARBARA
KY208.06
Düz şaft/Straight shaft
15 cm

45° 1.0 mm
BARBARA
KY208.10
Düz şaft/Straight shaft
16.5 cm



45°
1.0 mm
SHEA
KY208.10
Düz şaft/Straight shaft
17.5 cm

0.6 mm
BARBARA
KY210.05
Düz şaft/Straight shaft
16 cm



1.0 mm
90°
KY212.10
20° şaft/20° Shaft
15.5 cm



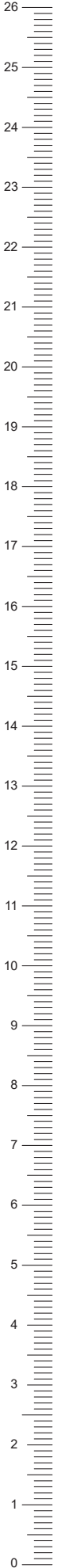

KY238.00



WILLIGER
Sivri/Sharp
12 cm

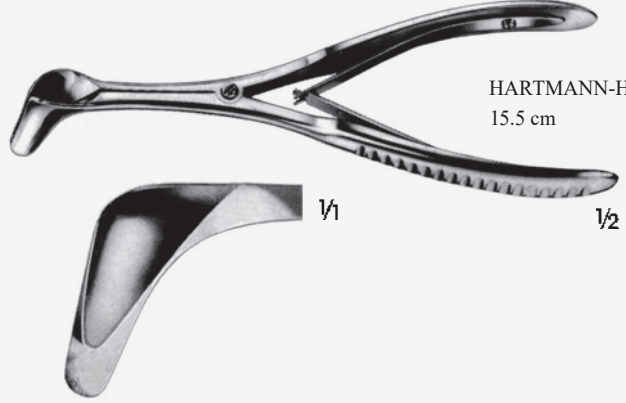

HARTMANN-HALLE
15.5 cm

KY311.02



BELLUCI
KI106.11 Künt/Blunt
Sol/Left
11 cm



BELLUCI
KI107.11 Künt/Blunt
Sağ/Right
11 cm



PLESTER
KI109.13 Künt/Blunt
13 cm



KJ122.16

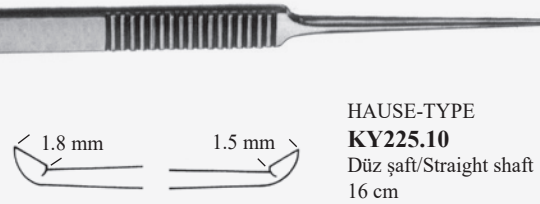
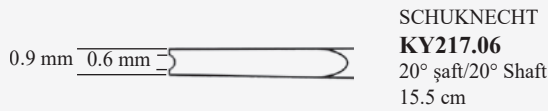
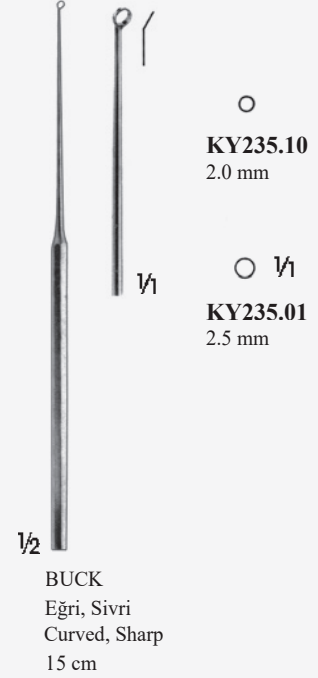



HARTMAN-WULLSTEIN
KY167.01 Ø 1 mm
Düz/Straight



HARTMAN-WULLSTEIN
KY167.02 Ø 2 mm
Düz/Straight

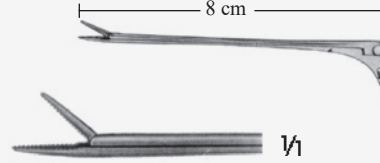

HARTMANN-WULLSTEIN
KY166.06 0.8 x 6 mm
Düz/Straight



DIETER
KY168.30
Düz şaft/Straight shaft
8 cm



MCGEE
KY168.12
Düz şaft/Straight shaft
8 cm



1/2
SCHUKNECHT
KY128.12

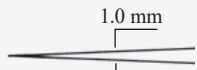

SCHEER
KY206.01
Düz şaft/Straight shaft
16 cm

KP202.00
Bipolar kordon
Bipolar cord
2 mt.

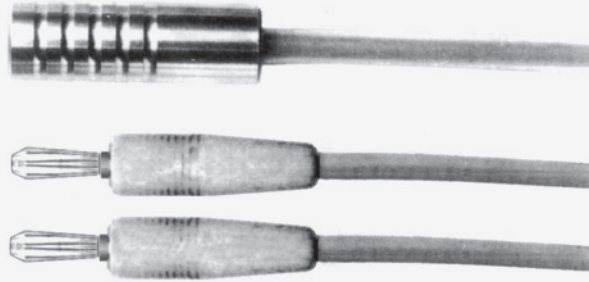

KP109.01 0.8 mm
20 cm
Izoleli/Insulated



STERILE CONTAINER
KC310.13
1/2 Size Container
285 x 280 x 135 mm



WIRE BASKET
KC390.05 For Sterile Container
Wire Baskets
255 x 245 x 50 mm



SILICONE MAT
KC851.00 For Sterile Container
Silicone Mat
245 x 245 mm



Nasal Septum Cerrahi Seti

Nasal Septum Surgery Set



 **KARAOĞLU**[®]



| No | Quantity | Code | Description |
|----|----------|-----------------|---|
| 1 | 1 | KY252.02 | Lempert Nasal Knife 15 cm |
| 2 | 1 | KY374.14 | Cottle Knife, 14 cm |
| 3 | 1 | KY332.26 | Krause Polypus Snare, 26 cm |
| 4 | 1 | KY335.10 | Snare Wire, Package of 12 pcs |
| 5 | 1 | KE223.10 | Delicate Scissors, Curved 11 cm |
| 6 | 1 | KE321.14 | Joseph Delicate Scissors, Curved 15 cm |
| 7 | 1 | KE433.11 | Chadwick Scissors, 11.5 cm |
| 8 | 1 | KE107.14 | Scissors, Curved, 14.5 cm |
| 9 | 1 | KE317.10 | Cottle-Knapp Scissors, Curved 10.5 cm |
| 10 | 1 | KE292.18 | Heymann-Knight Nasal Scissors, 17.5 cm |
| 11 | 1 | KY149.16 | Jansen Forcep, Bayonet-Shaped 16 cm |
| 12 | 1 | KD255.00 | Cottle Forcep, Bayonet-Shaped 14 cm |
| 13 | 1 | KY455.10 | Cottle Columella Clamp, 10 cm |
| 14 | 1 | KD100.11 | Standart Forcep, 11.5 cm |
| 15 | 1 | KD152.12 | Adson Tissue Forcep, 12 cm |
| 16 | 1 | KZ258.11 | Graefe Tissue Forcep, 11 cm |
| 17 | 1 | KD110.11 | Tissue Forcep, 11.5 cm |
| 18 | 1 | KY339.20 | Lubet-Barbon Dressing Forcep 20 cm |
| 19 | 6 | KG392.11 | Backhaus Towel Clamp, 11 cm |
| 20 | 1 | KF159.15 | Crile-Wood Needle Holder, 14.5 cm |
| 21 | 1 | KF181.18 | Sarot Needle Holder, 17.5 cm |
| 22 | 2 | KB266.16 | Lathbury-Farrel Cotton Applicator, Triangular Serrated, 16 cm |
| 23 | 1 | KB104.30 | Fergusson Suction Tube, With Luer Hub, Ø 3.0 mm, 20 cm |
| 24 | 1 | KY371.04 | Canulla, Sharp, 4 mm, 20 cm |
| 25 | 1 | KH451.14 | Cottle Retractor, 14 cm |
| 26 | 1 | KY633.19 | Brünings Tongue Depressor, 19 cm |
| 27 | 1 | KY320.01 | Cottle Nasal Speculum 35 x 7 mm, 13.5 cm |
| 28 | 1 | KY320.02 | Cottle Nasal Speculum 50 x 7 mm, 13.5 cm |
| 29 | 1 | KY318.02 | Cottle Nasal Speculum 50 x 7 mm, 13.5 cm |
| 30 | 1 | KY318.03 | Cottle Nasal Speculum 75 x 7 mm, 13.5 cm |
| 31 | 1 | KY318.04 | Cottle Nasal Speculum 90 x 7 mm, 13.5 cm |
| 32 | 1 | KY387.19 | Freer Elevator, Sharp, 19 cm |
| 33 | 1 | KY393.23 | Cottle Elevator, Sharp, 23 cm |
| 34 | 1 | KY399.20 | Cottle Elevator, Sharp, 20 cm |
| 35 | 1 | KY385.19 | Cottle Elevator, 19.5 cm |
| 36 | 1 | KY412.04 | Cottle Chisel 4 mm, 18 cm |
| 37 | 1 | KY412.07 | Cottle Chisel 7 mm, 18 cm |
| 38 | 1 | KK404.18 | Cottle Metal Mallet 240 gr 18.5 cm |
| 39 | 1 | KO156.02 | Weil-Blakesley Rongeur, Straight 3.6 mm, 12 cm |
| 40 | 1 | KO156.04 | Weil-Blakesley Rongeur, Straight 4.8 mm, 12 cm |
| 41 | 1 | KO157.02 | Weil-Blakesley Rongeur, Curved Upwards, 3.6 mm, 11 cm |
| 42 | 1 | KY348.12 | Takahashi Rongeur, Straight, 12 cm |
| 43 | 1 | KC310.15 | 1/2 Size Container, 285 x 280 x 150 mm |
| 44 | 2 | KC390.05 | Wire Baskets 255 x 245 x 50 mm |
| 45 | 1 | KP202.00 | Bipolar cord 2 mt. |
| 46 | 1 | KP109.01 | Bipolar Forceps, Insulated, 0.8 mm, 20 cm |

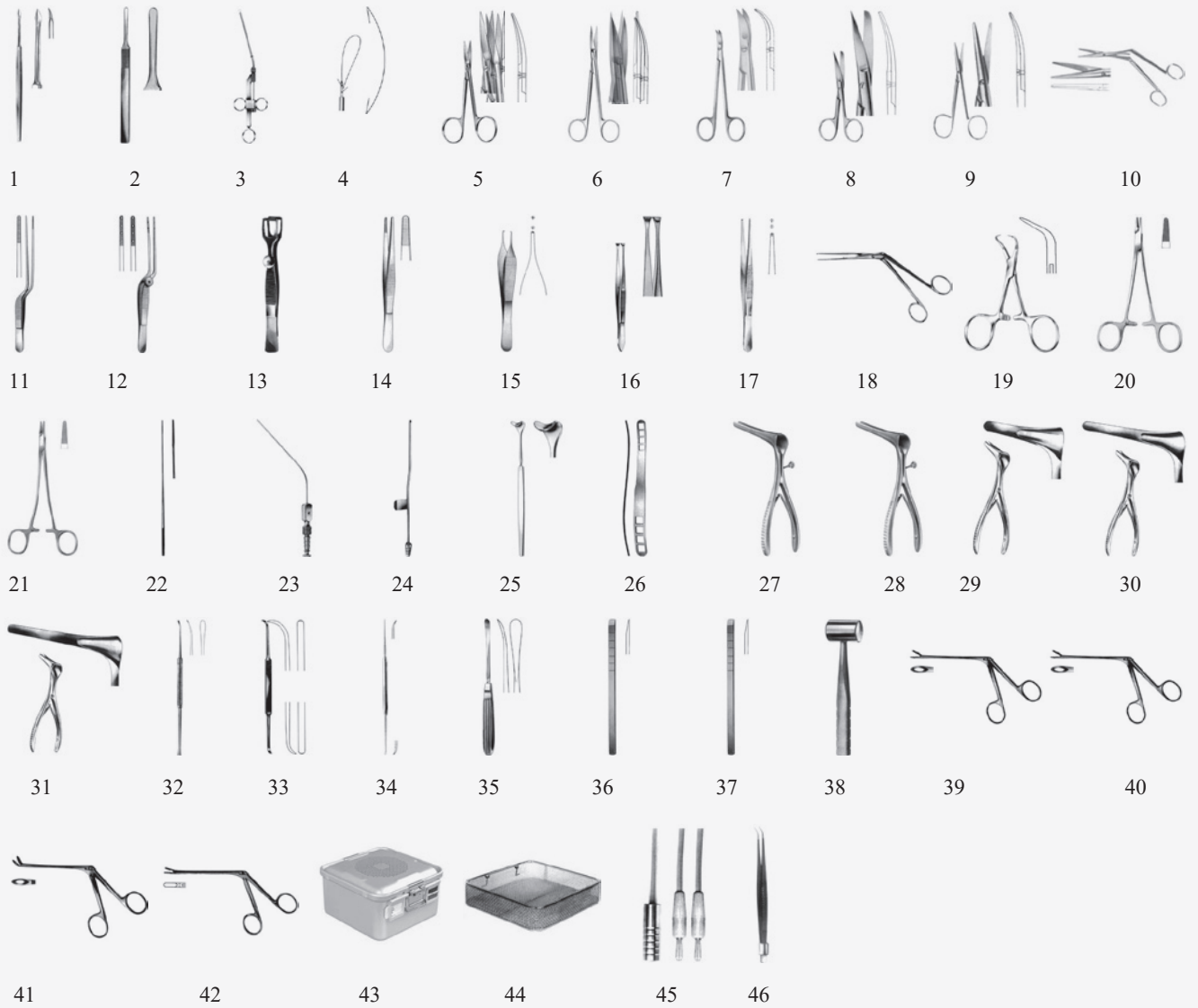

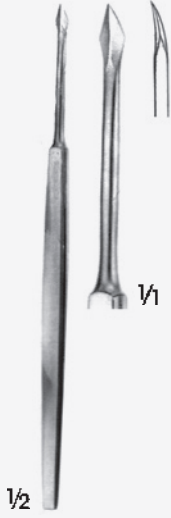

LEMPERT
KY252.02
15 cm



COTTLE
KY374.14
14 cm

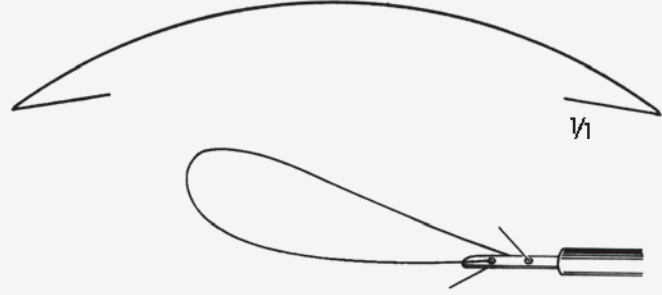

KY335.10 Ø 0.3 mm
12'lik paket
Package of 12 pcs

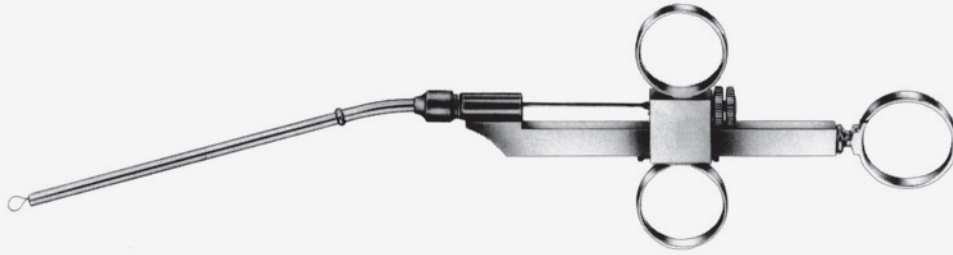

KRAUSE
KY332.26
26 cm



KE223.10
Eğri/Curved
Sivri/Sharp
11 cm



JOSEPH
15 cm

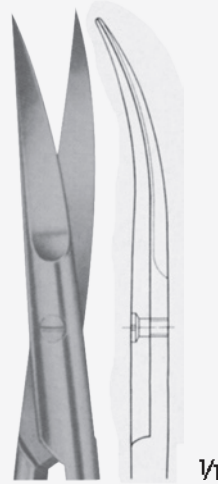

KE321.14
Eğri/Curved
Sivri/Sharp



CHADWICK
KE433.11
11.5 cm

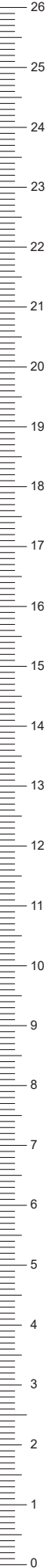
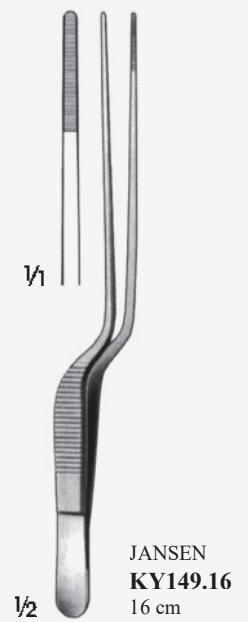
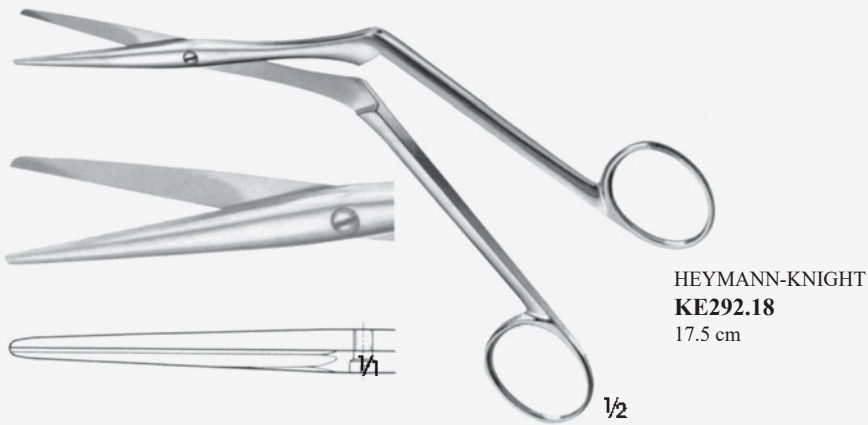

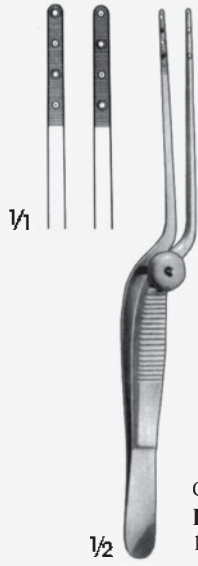

COTTLE
KD255.00
14 cm



COTTLE
KY455.10
10 cm



STANDART



KD100.11
11.5 cm



ADSON
KD152.12
12 cm

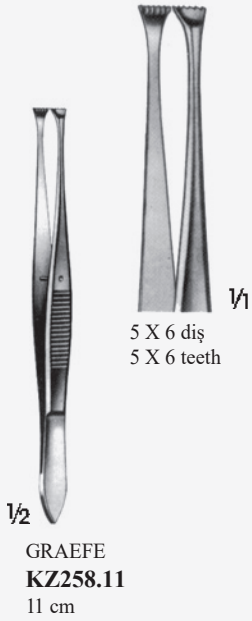

GRAEFE
KZ258.11
11 cm



5 X 6 diş
5 X 6 teeth



KD110.11
11.5 cm



BACKHAUS

KG392.11
11 cm



LUBET-BARBON
KY339.20
20 cm

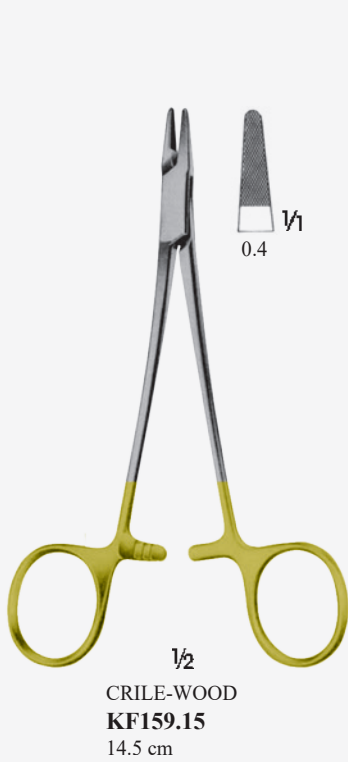

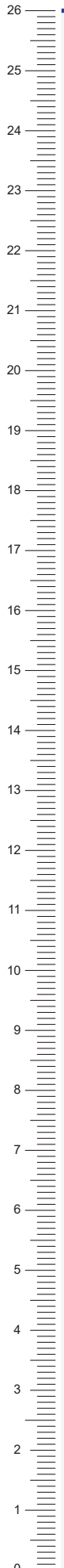

COTTLE
13.5 cm

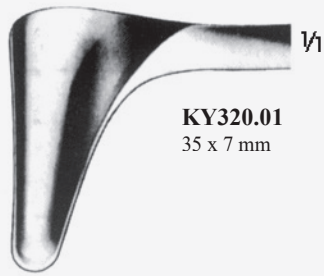

KY320.01
35 x 7 mm



KY320.02
50 x 7 mm



COTTLE
13.5 cm



KY318.02
50 x 7 mm



KY318.03
75 x 7 mm



KY318.04
90 x 7 mm



FREER
KY387.19
Sivri/Sharp
19 cm



COTTLE
KY393.23
Sivri/Sharp
23 cm



COTTLE
KY399.20
Sivri/Sharp
20 cm

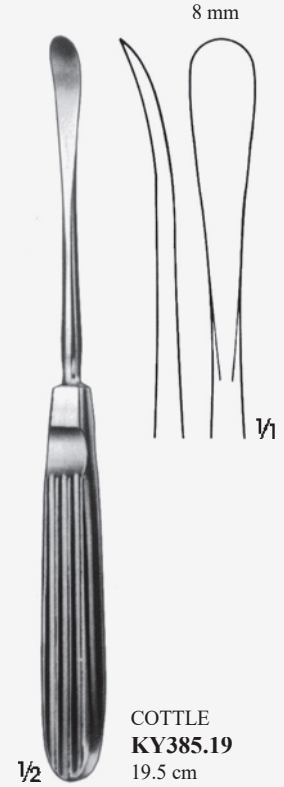

COTTLE
KY385.19
19.5 cm



COTTLE
KY412.04 4 mm
KY412.07 7 mm
18 cm



Ø 30 mm

COTTLE
KK404.18 240 gr.
18.5 cm

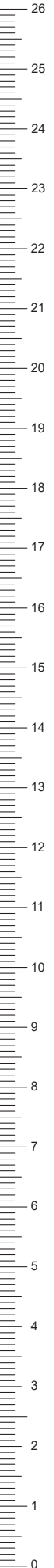

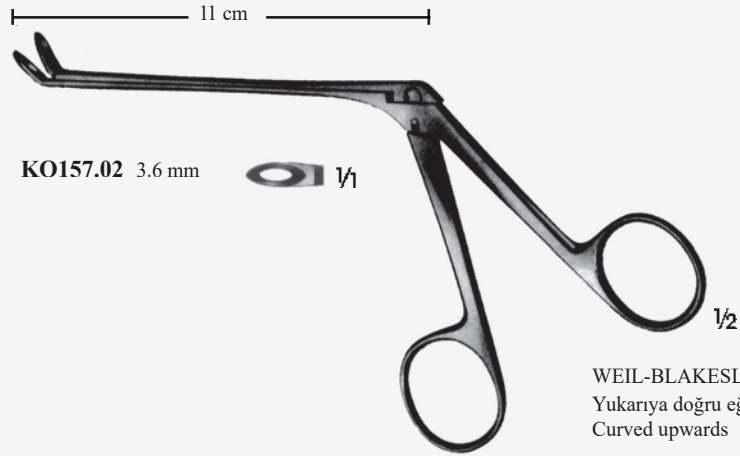
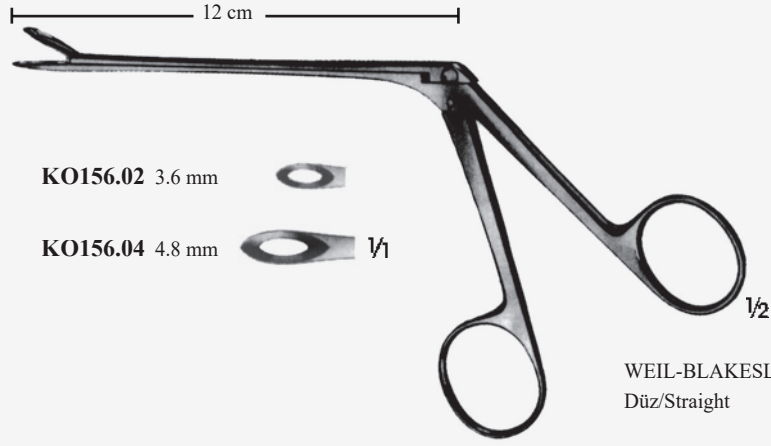
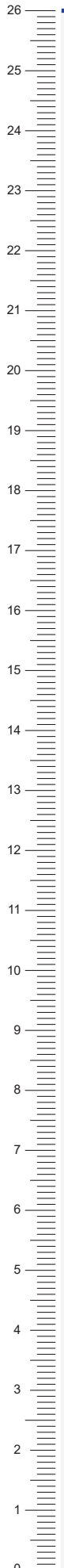

KP202.00
Bipolar kordon
Bipolar cord
2 mt.

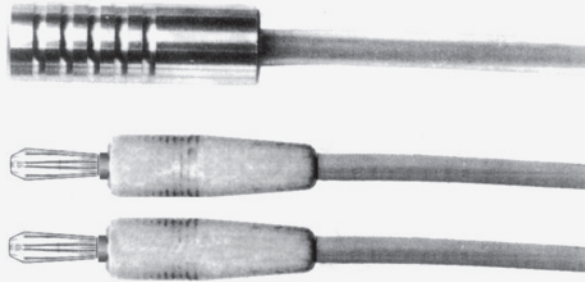

STERILE CONTAINER
KC310.15
1/2 Size Container
285 x 280 x 150 mm

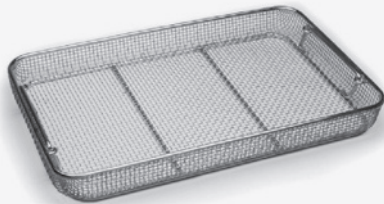

WIRE BASKET
KC390.05 For Sterile Container
Wire Baskets
255 x 245 x 50 mm



KP109.01 0.8 mm
20 cm
Izoleli/Insulated

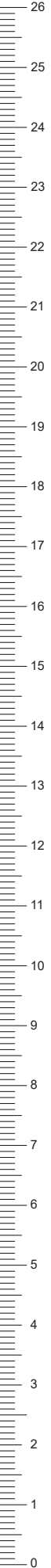

Rinoplasti Seti

Rhinoplasty Set



 **KARAOĞLU**[®]



| No | Quantity | Code | Description |
|----|----------|-----------------|--|
| 1 | 1 | KA100.07 | Scalpel Handle, 3 No, 16 cm |
| 2 | 1 | KY252.02 | Lempert Nasal Knife, 15 cm |
| 3 | 1 | KY374.14 | Cottle Nasal Knife, 14 cm |
| 4 | 1 | KE255.10 | Delicate Scissors, curved, 9 cm |
| 5 | 1 | KE223.11 | Delicate Scissors, curved, 11 cm |
| 6 | 1 | KE321.14 | Joseph Delicate Scissors, curved, 15 cm |
| 7 | 1 | KE433.11 | Chadwick Delicate scissors, curved, 11.5 cm |
| 8 | 1 | KE101.13 | Scissors, straight, 13 cm |
| 9 | 1 | KD255.00 | Cottle Forceps, Bayonet-Shaped, 14 cm |
| 10 | 1 | KY455.10 | Cottle Camella Clamp, 10 cm |
| 11 | 1 | KD152.12 | Adson Tissue Forcep, 12 cm |
| 12 | 1 | KF164.12 | Converse Needle Holder, 13 cm |
| 13 | 1 | KF181.18 | Sarot Needle Holder, 17.5 cm |
| 14 | 3 | KB266.16 | Labhbury-Farrel Cotton Applicator, Triangular Serrated |
| 15 | 1 | KB120.30 | Frazier Suction Tube, With Luer Hub, Ø 3 mm, 18 cm |
| 16 | 1 | KB120.50 | Frazier Suction Tube, With Luer Hub, Ø 5 mm, 18 cm |
| 17 | 1 | KY368.18 | Suction Tube, With Luer Hub, 18 cm |
| 18 | 1 | KY371.04 | Canulla, Sharp, 4 mm, 20 cm |
| 19 | 1 | KY438.15 | Cottle Hook, 16 cm |
| 20 | 1 | KY449.14 | Cottle Retractor, Right Sharp, 14.5 cm |
| 21 | 1 | KY450.14 | Cottle Retractor, Left Sharp, 14.5 cm |
| 22 | 1 | KY446.20 | Cottle Retractor, Blunt, 20 cm |
| 23 | 1 | KY451.14 | Cottle Retractor, 14 cm |
| 24 | 1 | KY454.16 | Aufricht Retractor, 16 cm |
| 25 | 1 | KY318.02 | Cottle Nasal Speculum 50 x 7 mm, 13.5 cm |
| 26 | 1 | KY318.03 | Cottle Nasal Speculum 75 x 7 mm, 13.5 cm |
| 27 | 1 | KY318.04 | Cottle Nasal Speculum 90 x 7 mm, 13.5 cm |
| 28 | 1 | KY393.23 | Cottle Elevator, 23 cm |
| 29 | 1 | KY399.20 | Masing Elevator, 20 cm |
| 30 | 1 | KJ121.15 | Konig Raspatory, 5 mm, 15.5 cm |
| 31 | 1 | KY412.04 | Cottle Chisel, 4 mm, 18 cm |
| 32 | 1 | KY412.07 | Cottle Chisel, 7 mm, 18 cm |
| 33 | 1 | KY412.09 | Cottle Chisel, 9 mm, 18 cm |
| 34 | 1 | KY416.02 | Masing Chisel, Straight, 17.5 cm |
| 35 | 1 | KY416.01 | Masing Chisel, Right, Curved, 17.5 cm |
| 36 | 1 | KY416.03 | Masing Chisel, Left Curved, 17.5 cm |
| 37 | 1 | KK404.18 | Cottle Metal Mallet, 240 gr. 18.5 cm, 40 mm |
| 38 | 1 | KY433.21 | Fomon Raspatorie, 21.5 cm |
| 39 | 1 | KY434.21 | Fomon Raspatorie, 21.5 cm |
| 40 | 1 | KY460.22 | Cottle-Walsham Septum Forcep, 22 cm |
| 41 | 1 | KM408.18 | Kazanjian Bone Rongeur, 18.5 cm |
| 42 | 1 | KY362.19 | Jansen-Middleton Septum Bone Lever, 19 cm |
| 43 | 1 | KY350.02 | Watson-Williams Rongeur, 7 mm, 12 cm |
| 44 | 1 | KY352.02 | Weil-Blakesley Rongeur, 3.6 mm, 12 cm |
| 45 | 1 | KY352.04 | Weil-Blakesley Rongeur, 4.8 mm, 12 cm |
| 46 | 1 | KY420.00 | Bone Crusher |
| 47 | 1 | KY422.02 | Joseph Nasal Saw, Curved to Right, 19 cm |
| 48 | 1 | KY422.01 | Joseph Nasal Saw, Curved to Left, 19 cm |
| 49 | 1 | KC310.15 | 1/2 Size Container, 285 x 280 x 150 mm |
| 50 | 2 | KC390.05 | Wire Baskets 255 x 245 x 50 mm |

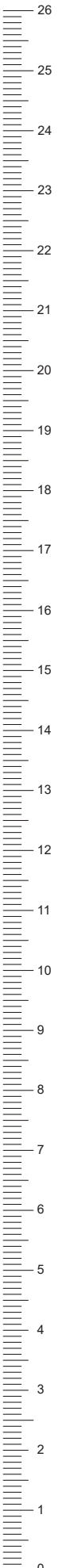
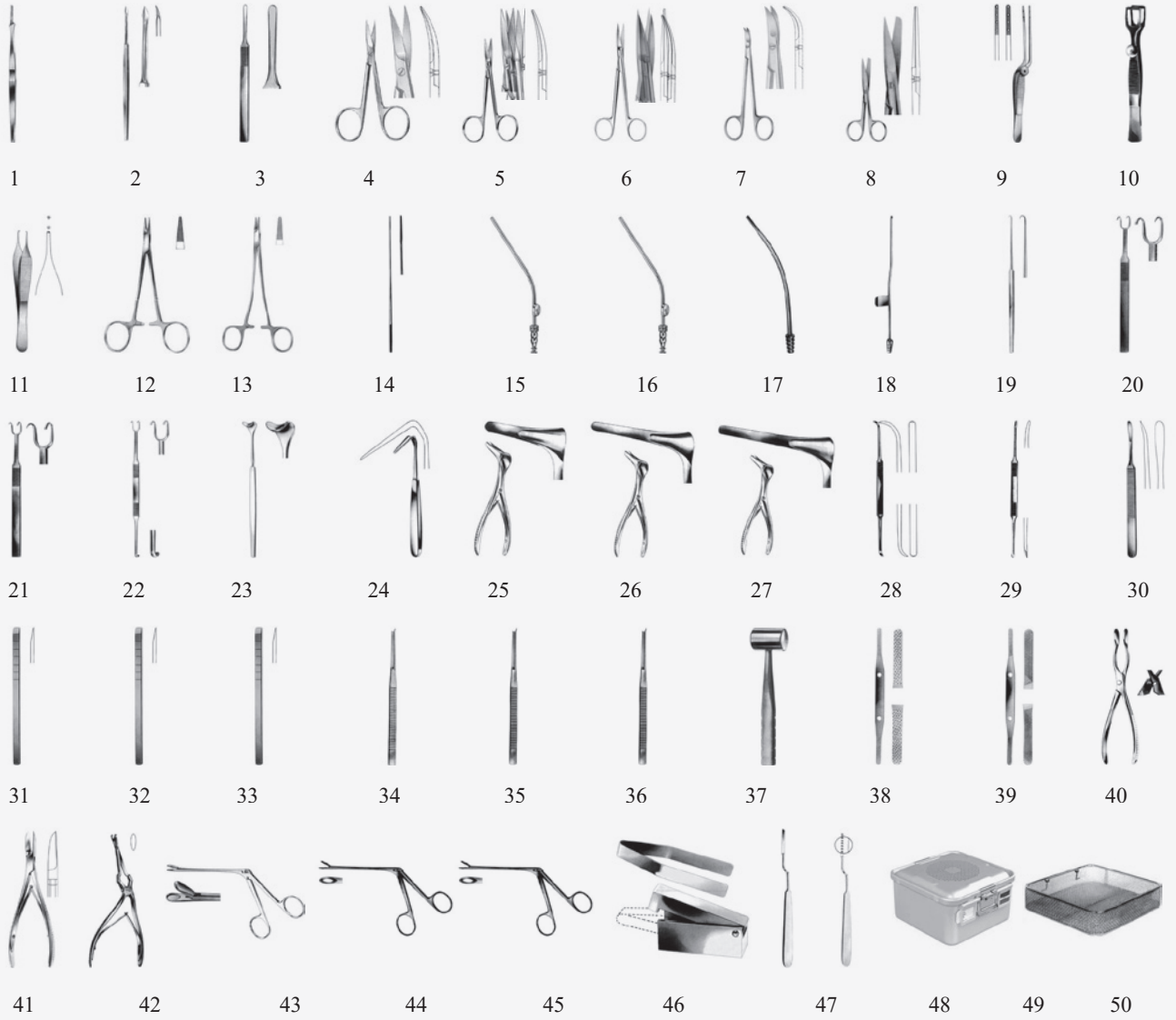

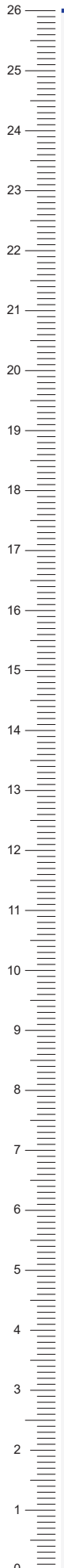

KA100.07
16 cm
3 No

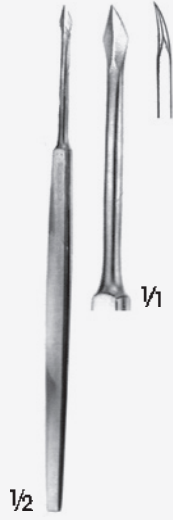

$\frac{1}{2}$
LEMPRT
KY252.02
15 cm



$\frac{1}{2}$
COTTLE
KY374.14
14 cm



$\frac{1}{2}$

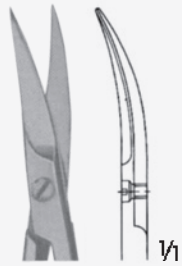

KE255.10
Eğri/Curved
9 cm

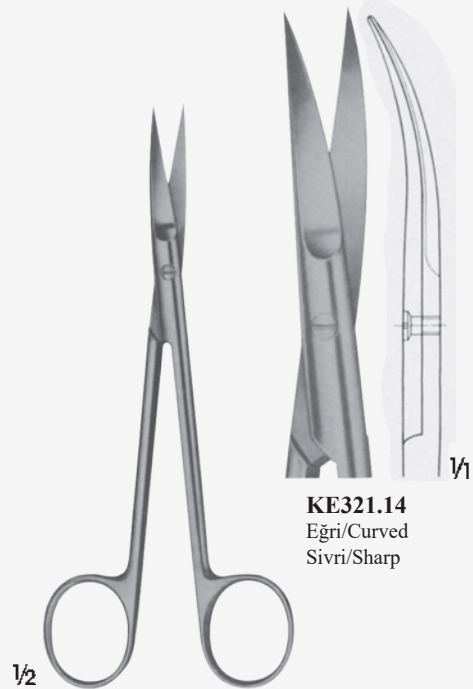

$\frac{1}{2}$

JOSEPH
15 cm

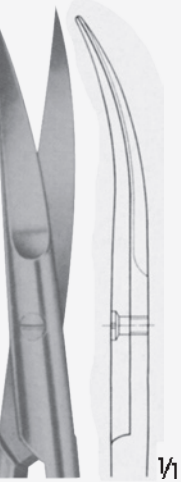

KE321.14
Eğri/Curved
Sivri/Sharp

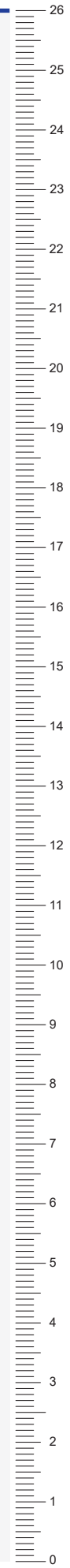
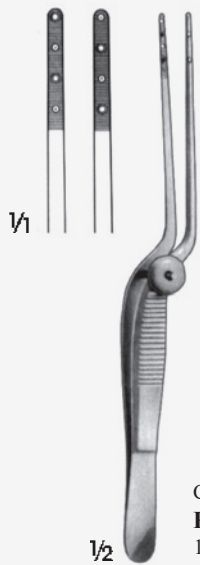
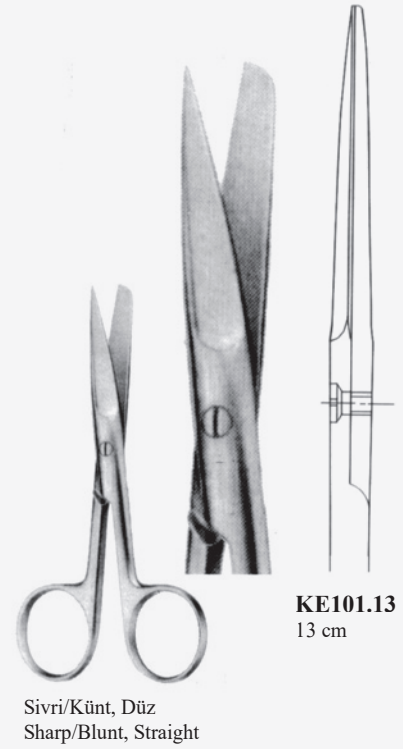
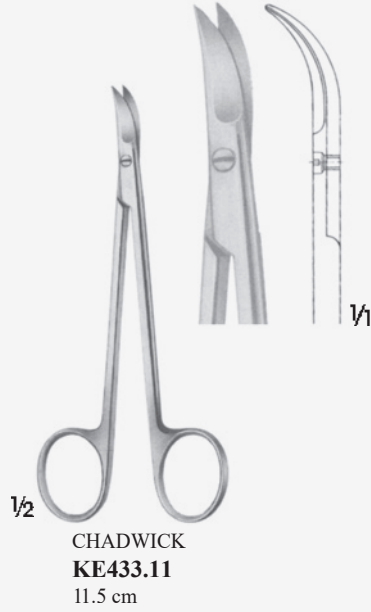
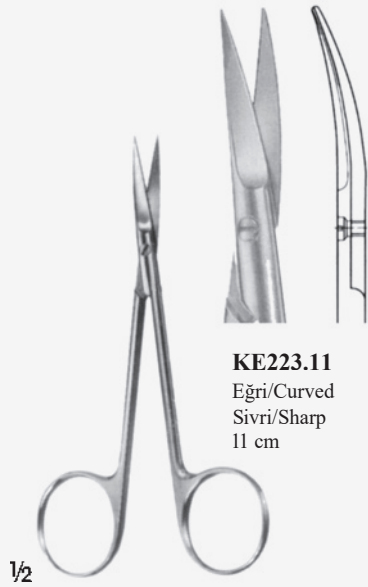

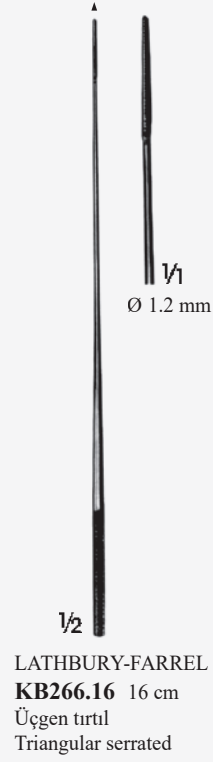



COTTLE
KY438.15
16 cm



COTTLE
KY449.14
Sağ sivri/Right sharp
14.5 cm



COTTLE
KY450.14
Sol sivri/Left sharp
14.5 cm



COTTLE
KY446.20
Künt/Blunt
20 cm



COTTLE
KY451.14
14 cm

AUFRICHT
KY454.16
16 cm

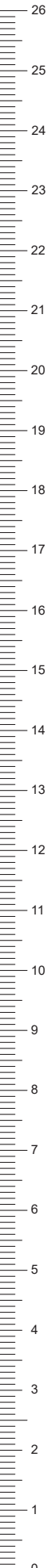

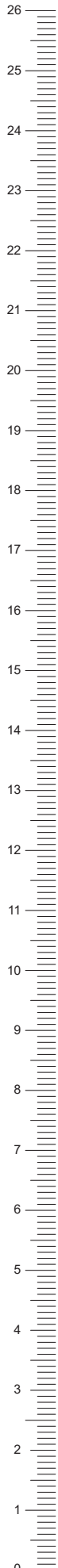

1/2
COTTLE
13.5 cm



KY318.02
50 x 7 mm



KY318.03
75 x 7 mm



KY318.04
90 x 7 mm
1/1



1/2
COTTLE
KY393.23 Sivri/Sharp
Sivri/Sharp
23 cm



1/2
MASING
KY399.20 Künt/Blunt
Sivri/Sharp
20 cm

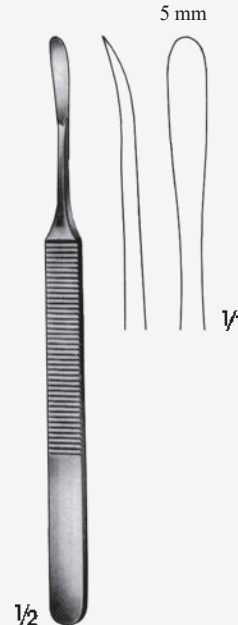

1/2
KONIG
KJ121.15
15.5 cm



1/2
COTTLE
KY412.04 4 mm
KY412.07 7 mm
KY412.09 9 mm
18 cm

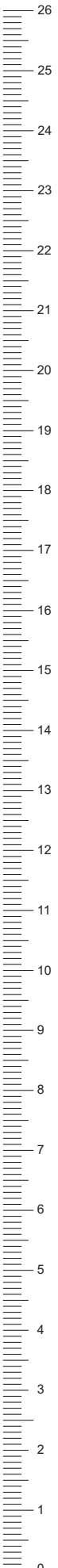
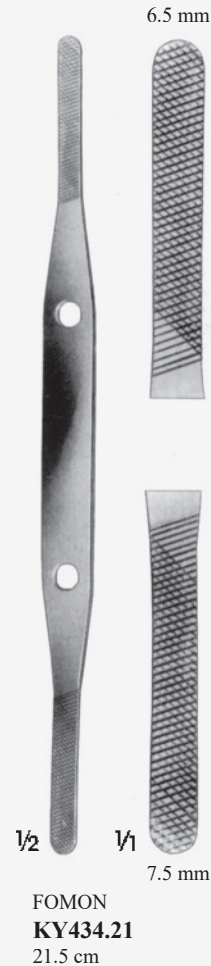
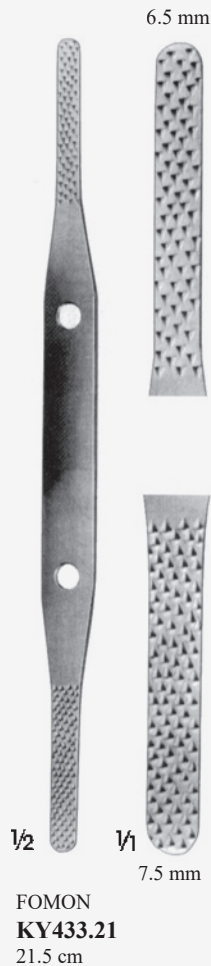

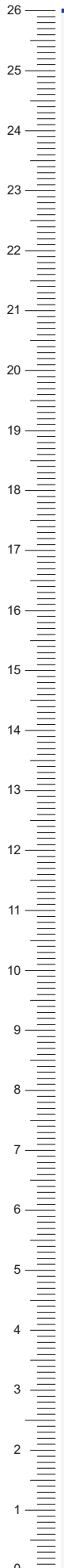

COTTLE-WALSHAM
KY460.22
22 cm



KAZANJIAN
KM408.18
18.5 cm



JANSEN-MIDDLETON
KY362.19
19 cm

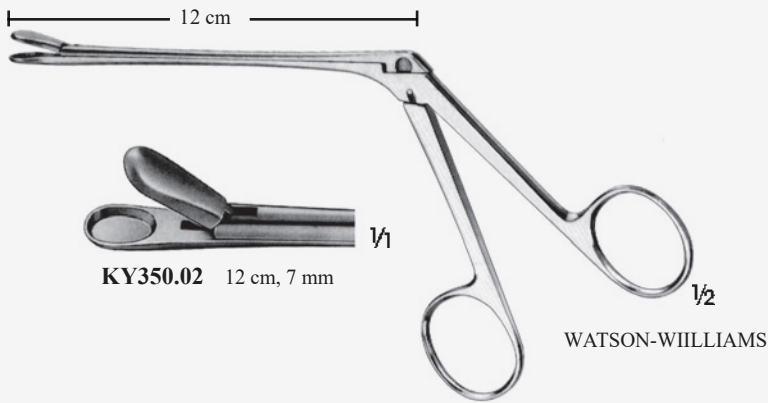

KY350.02 12 cm, 7 mm

WATSON-WILLIAMS

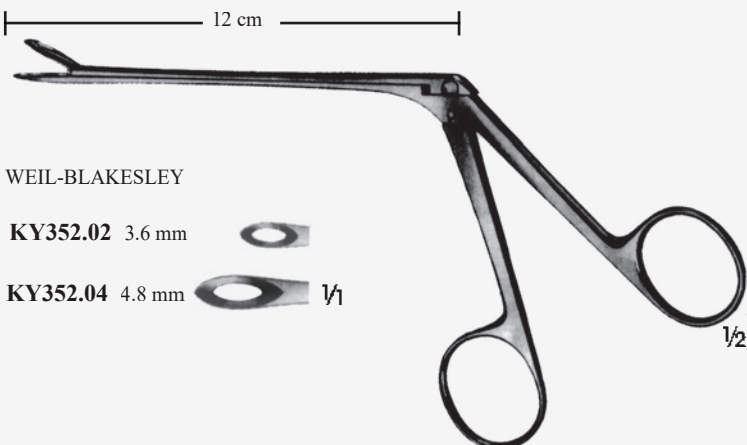

WEIL-BLAKESLEY

KY352.02 3.6 mm

KY352.04 4.8 mm

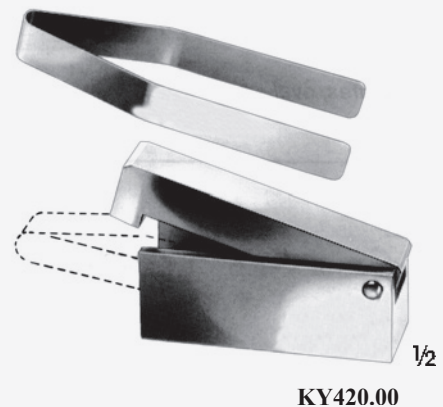

KY420.00



1/2

JOSEPH
KY422.02
Sola doğru eğri,
Curved to left
19 cm



1/2

JOSEPH
KY422.01
Sağa doğru eğri,
Curved to right
19 cm



STERILE CONTAINER
KC310.15
1/2 Size Container
285 x 280 x 150 mm

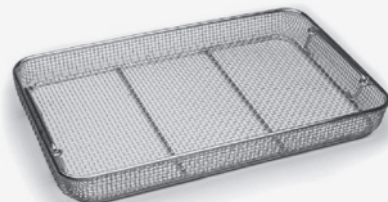

WIRE BASKET
KC390.05 For Sterile Container
Wire Baskets
255 x 245 x 50 mm

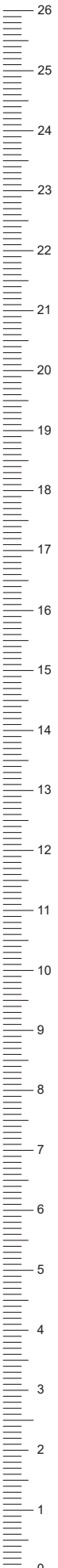

Tonsillektomi ve Adenoidektomi Seti •

Tonsillectomy And Adenoidectomy Set



 **KARAOĞLU**®



| No | Quantity | Code | Description |
|----|----------|------------------|--|
| 1 | 1 | KY700.10 | Laryngeal Mirror, Ø 10 mm |
| 2 | 1 | KY700.16 | Laryngeal Mirror, Ø 16 mm |
| 3 | 1 | KY641.25 | Eyes Tonsil Snare, 25 cm |
| 4 | 1 | KY637.05 | Wire Snare, Package of 12 pcs, Ø 0.5 mm |
| 5 | 1 | KY696.19 | Good Scissors 19.5 cm |
| 6 | 1 | KD185.18 | Cushing Dissecting Forcep 18 cm |
| 7 | 1 | KD206.20 | Waugh Tissue Forcep, 20 cm |
| 8 | 1 | KY698.20 | Colven Forcep, 20.5 cm |
| 9 | 1 | KY697.01 | Blohmke Forcep, 20.5 cm |
| 10 | 6 | KG392.11 | Backhaus Towel Clamp, 11 cm |
| 11 | 1 | KF181.18 | Sarot Needle Holder, 18 cm |
| 12 | 1 | KG189.19 | Schmidt Forcep, Curved, 19 cm |
| 13 | 1 | KY699.18 | Mikulicz Forcep, Curved, 18.5 cm |
| 14 | 1 | KB188.27 | Yankauer Suction Tube 27 cm |
| 15 | 1 | KB234.10 | Tonsil Needle, Straight |
| 16 | 1 | KY633.19 | Brünings Tongue Depressor 19 cm |
| 17 | 1 | KY627.16 | Tobold Tongue Depressor, 16 cm |
| 18 | 1 | KY603.00 | Davis-Meyer Mouth Gag |
| 19 | 1 | KY601.00 | McIvor Mouth Gag |
| 20 | 1 | KY606.01 | Russel-Davis Tongue Blade 29 x 67 |
| 21 | 1 | KY606.02 | Russel-Davis Tongue Blade 33 x 75 |
| 22 | 1 | KY606.03 | Russel-Davis Tongue Blade 38 x 85 |
| 23 | 1 | KY606.04 | Russel-Davis Tongue Blade 40 x 92 |
| 24 | 1 | KY693.23 | Henkel Dissector, 12 mm Wide, 23.5 cm |
| 25 | 1 | KY646.20 | Beckmann Adenoid Curette, Straight, 20 cm |
| 26 | 1 | KY647.20 | Beckmann Adenoid Curette, Straight, 20 cm |
| 27 | 1 | KY648.20 | Beckmann Adenoid Curette, Straight, 20 cm |
| 28 | 1 | KY649.20 | Beckmann Adenoid Curette, Straight, 20 cm |
| 29 | 1 | KY650.20 | Beckmann Adenoid Curette, Sstraight, 20 cm |
| 30 | 1 | KY671.20 | Negus Adenoid Curette, 20 cm |
| 31 | 1 | KY366.01 | Jurasz Tonsil Forcep, 22 cm |
| 32 | 1 | KY347.03 | Brünings Ronguer, Round, 19 cm |
| 33 | 1 | KC290.05 | Wire Basket, 405 x 255 x 50 mm |
| 34 | 1 | KC210.10B | 3/4 Size Container, 465 x 280 x 100 mm |
| 35 | 1 | KP202.00 | Bipolar Cord, 2 mt. |
| 36 | 1 | KP109.01 | Bipolar Forcep, insulated, 20 cm |

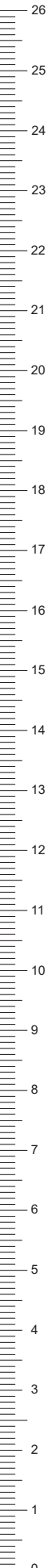
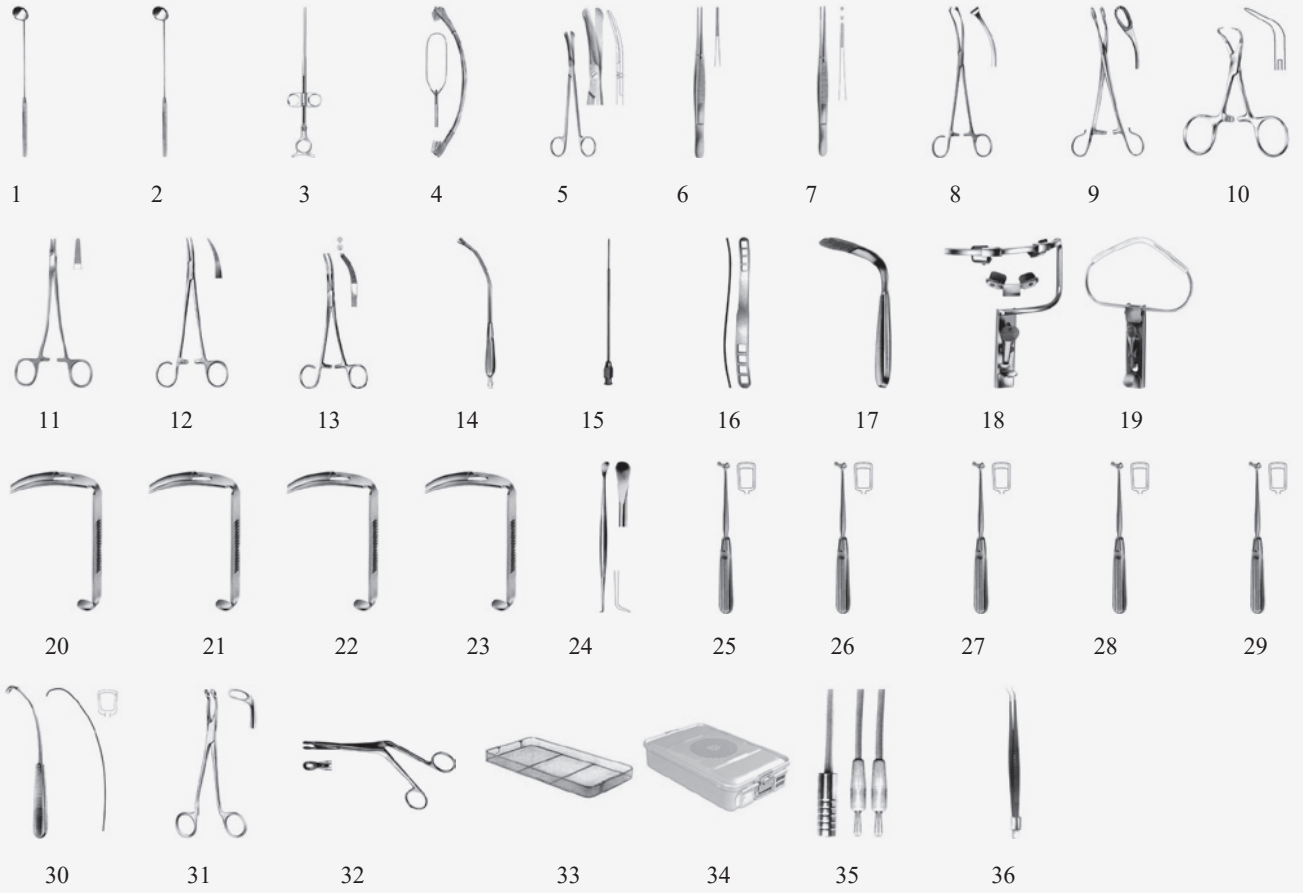



KY700.10
Fig. 0
Ø 10 mm



KY700.16
Fig. 3
Ø 16 mm

Altıgen saplı Laringel
aynalar
Laryngeal mirrors with
Hexagonal handle
18 cm

1/2



EVES
KY641.25
25 cm

1/2

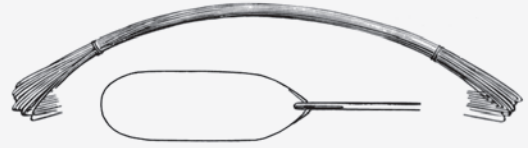

KY637.05 Ø 0.5 mm
12'lik paket/Package of 12 pcs

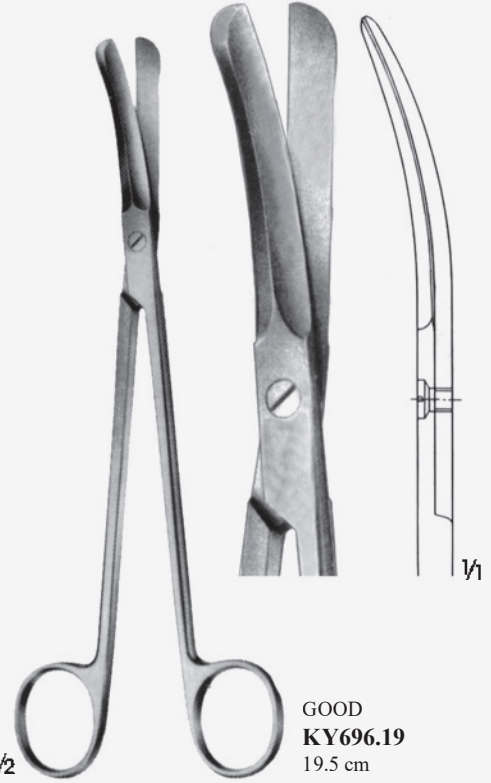

GOOD
KY696.19
19.5 cm

1/2



KD185.18
18 cm

CUSHING

1/1



KD206.20
20 cm

WAUGH

1/1



COLVER
KY698.20
20 cm

1/2

1/1

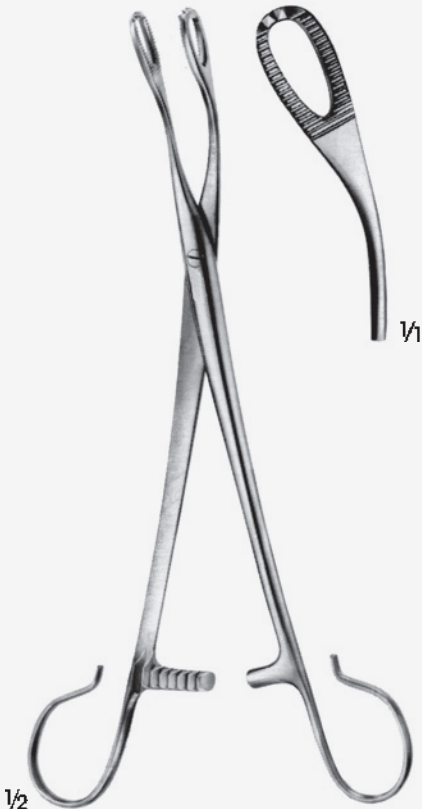

BLOHMKE
KY697.01
20.5 cm

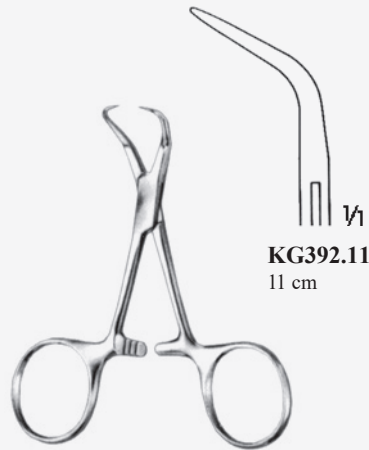

BACKHAUS

KG392.11
11 cm



SAROT
KF181.18
18 cm



SCHNIDT
19 cm

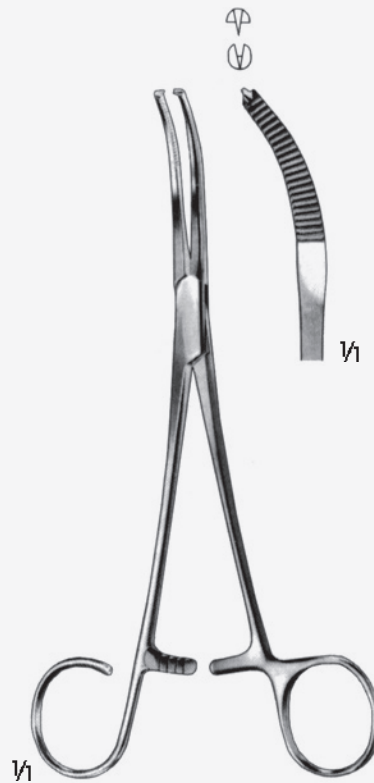

MIKULICZ
KY699.18
18.5 cm

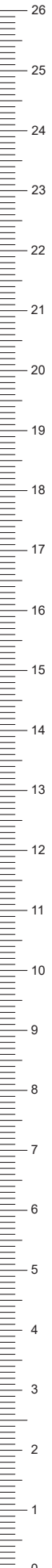



YANKAUER
KB188.27 Ø 4.8 mm
27 cm

Olive
Ø 7-9 mm



KB234.10
Luer-Lock, Düz
Luer-Lock, Straight



BRÜNINGS
KY633.19
19 cm

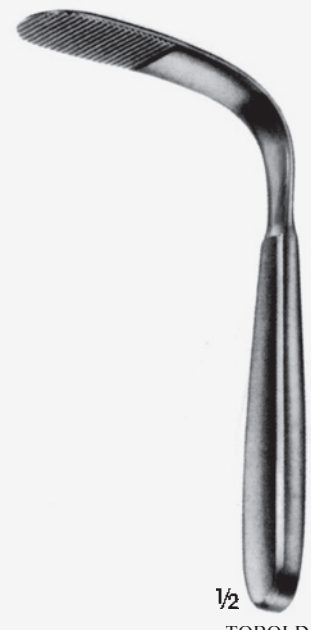

TOBOLD
KY627.16
16 cm



DAVIS-MEYER
KY603.00



McIVOR
KY601.00

26
25
24
23
22
21
20
19
18
17
16
15
14
13
12
11
10
9
8
7
6
5
4
3
2
1
0



RUSSEL-DAVIS

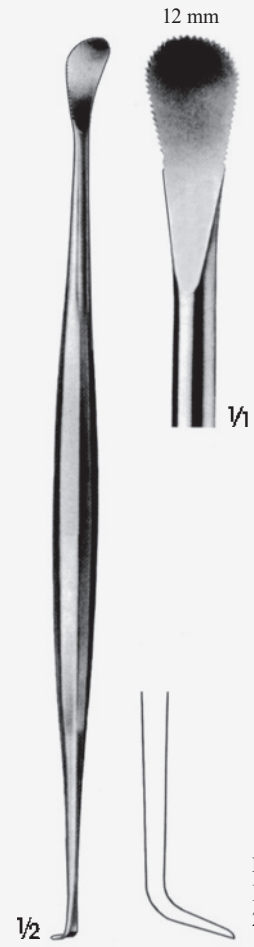

BECKMANN
20 cm

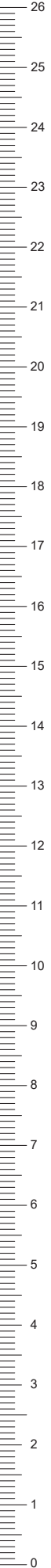
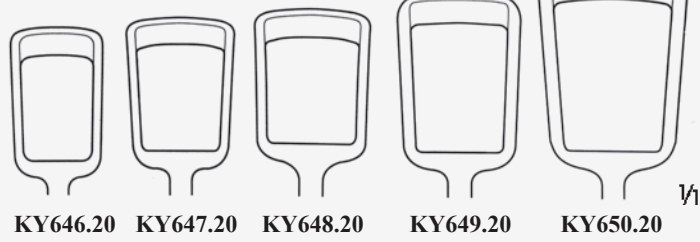

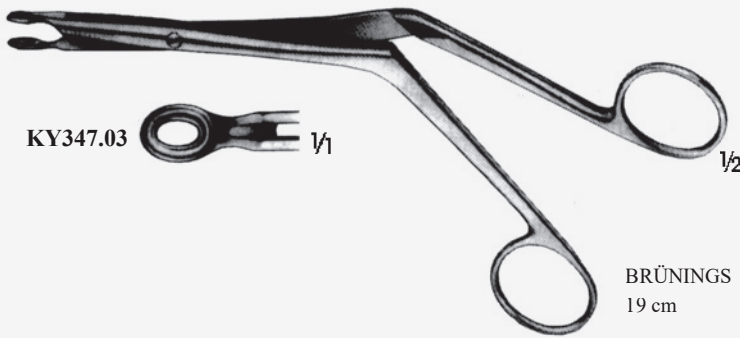
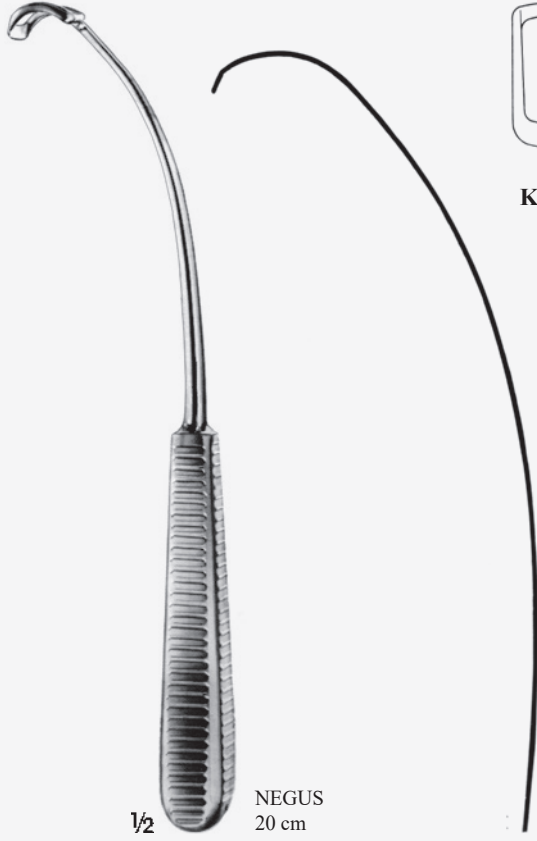

KP202.00
Bipolar kordon
Bipolar cord
2 mt.

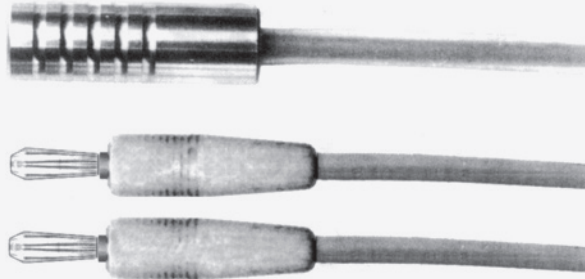

Izoleli
Insulated

KP109.01 0.9 mm
20 cm
Izoleli/Insulated



STERILE CONTAINER
KC210.10B
3/4 Size Container
465 x 280 x 100 mm

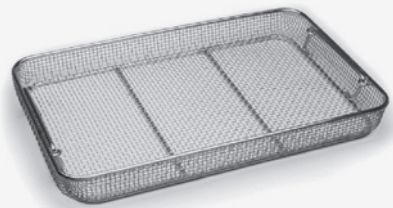

WIRE BASKET
KC290.05 For Sterile Container
Wire Baskets
405 x 255 x 50 mm

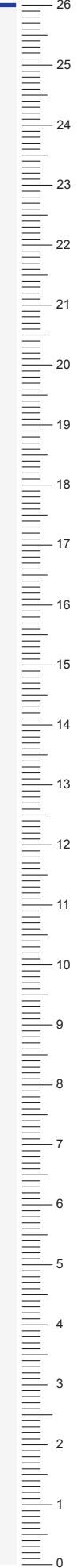

Trakeostomi Seti

Tracheostomy Set



 **KARAOĞLU**[®]



| No | Quantity | Code | Description |
|----|----------|-----------------|---|
| 1 | 1 | KA100.03 | Scalpel Handle, 3 No, 13.5 cm |
| 2 | 1 | KE321.14 | Joseph Scissors, curved 14 cm |
| 3 | 1 | KE107.14 | Scissors, curved, 14.5 cm |
| 4 | 1 | KE357.15 | Dissecting Scissors, curved, 15 cm |
| 5 | 1 | KE253.10 | Cottle-Knapp Scissors, curved, blunt, 10.5 cm |
| 6 | 1 | KE164.18 | Medzenbaum Scissors, 18 cm |
| 7 | 1 | KY365.00 | Killian Scissors, both jaws serrated, 20cm |
| 8 | 1 | KD140.12 | Adson Forceps, 12 cm |
| 9 | 1 | KD100.16 | Standart Forceps, 16 cm |
| 10 | 2 | KD110.14 | Standart Tissue Forceps, 14.5 cm |
| 11 | 1 | KD115.14 | Tissue Forceps, 14.5 cm |
| 12 | 1 | KD115.16 | Tissue Forceps, 16 cm |
| 13 | 1 | KY696.21 | Duplay Dressing Forceps, 21 cm |
| 14 | 6 | KG392.11 | Backhaus Towel Clamp, 11 cm |
| 15 | 1 | KF145.16 | Hegar-Mayo Needle Holder, 16 cm |
| 16 | 1 | KF145.18 | Hegar-Mayo Needle Holder, 18 cm |
| 17 | 8 | KG131.12 | Micro-Mosquito, Curved, 12 cm |
| 18 | 2 | KG145.14 | Crille Forceps, straight, 14 cm |
| 19 | 2 | KG151.14 | Crille Forceps, straight, 14 cm |
| 20 | 1 | KG147.16 | Crille Forceps, straight, 16 cm |
| 21 | 1 | KG191.19 | Birkett Forceps, straight, 19 cm |
| 22 | 2 | KY698.02 | Schmidt Forceps, curved, 18.5 cm |
| 23 | 2 | KB266.16 | Lathbury-Farrel Cotton Applicator, Triangular serrated, 14 cm |
| 24 | 1 | KB104.20 | Fergusson Suction Tube, With Luer Hub, Ø 2.0 mm, 20 cm |
| 25 | 1 | KB104.30 | Fergusson Suction Tube, With Luer Hub, Ø 3.0 mm, 20 cm |
| 26 | 1 | KY530.25 | Siebenmann Canulla, Blunt, Ø 2.5 mm, 13 cm |
| 27 | 1 | KY533.05 | Canulla, Ø 5.5 mm, 17.5 cm |
| 28 | 1 | KY533.16 | Wullstein Suction Tube, With Luer Hub, 16 cm |
| 29 | 1 | KY708.01 | Killian Cotton Carrier, curved, 25 cm |
| 30 | 1 | KY441.15 | Freer Hook, 15 cm |
| 31 | 1 | KY438.15 | Cottle Hook 15 cm |
| 32 | 1 | KH230.01 | Kocher Retractor, 19 cm |
| 33 | 2 | KH226.03 | Langenbeck Retractor, 33 x 14 mm, 21 cm |
| 34 | 2 | KH226.06 | Langenbeck Retractor, 40 x 13 mm, 21 cm |
| 35 | 1 | KY633.19 | Brünings Tongue Depressor, 19 cm |
| 36 | 1 | KY319.02 | Cottle Nasal Speculum, 50 x 7 mm, 15 cm |
| 37 | 1 | KY319.03 | Cottle Nasal Speculum, 75 x 7 mm, 15 cm |
| 38 | 1 | KY319.04 | Cottle Nasal Speculum, 90 x 7 mm, 15 cm |
| 39 | 1 | KI123.13 | Wullstein Self-Retaining Retractor, Blunt, 13 cm |
| 40 | 1 | KI136.13 | Adson-Baby Self-Retaining Retractor, Blunt, 13 cm |
| 41 | 1 | KY388.18 | Freer Elevator, 18.5 cm |
| 42 | 1 | KY400.16 | Joseph Elevator, 16 cm, 4 mm |
| 43 | 1 | KJ157.15 | Konig Elevator, 15.5 cm |
| 44 | 1 | KJ147.18 | Yankauer Elevator, 19.5 cm |
| 45 | 1 | KY360.02 | Hartmann Ronguer, 12 cm |
| 46 | 1 | KC310.13 | 1/2 Size Container, 285 x 280 x 135 mm |
| 47 | 1 | KC390.03 | Wire Basket, 255 x 245 x 30 mm |
| 48 | 1 | KC390.07 | Wire Basket, 255 x 245 x 70 mm |
| 49 | 1 | KP202.00 | Bipolar Cord, 2 mt. |
| 50 | 1 | KP100.11 | Bipolar Forcep, Insulated, 1.3 mm, 17.5 cm |
| 51 | 1 | KP109.01 | Bipolar Forcep, Insulated, 0.8 mm, 20 cm |



1



2



3



4



5



6



7



8



9



10



11



12



13

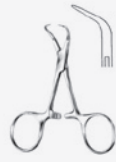

14



15



16



17



18



19



20



21



22



23



24



25



26



27



28



29



30



31



32



33



34



35



36



37



38



39



40



41



42



43



44



45



46

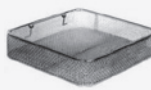

47

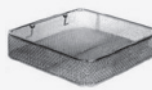

48



49



50



51

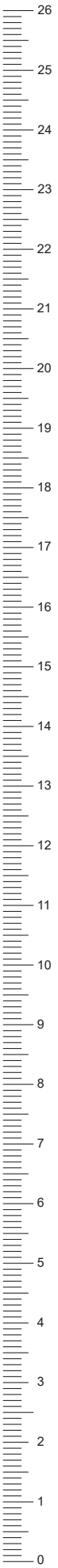

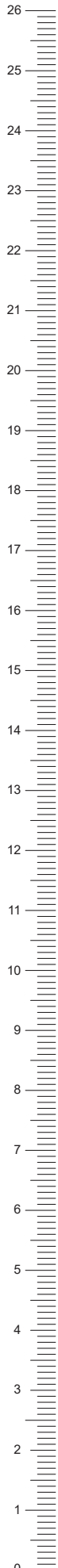

$\frac{1}{1}$
KA100.03
13.5 cm

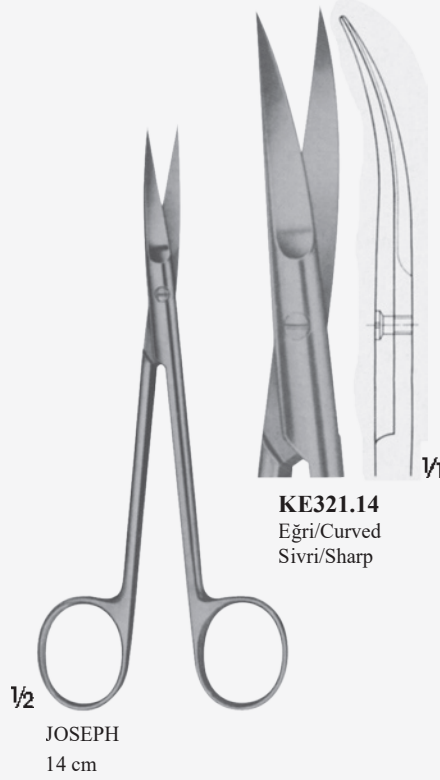

$\frac{1}{2}$
JOSEPH
14 cm

KE321.14
Eğri/Curved
Sivri/Sharp



Sivri/Künt, Eğri
Sharp/Blunt, Curved



KE107.14
14.5 cm

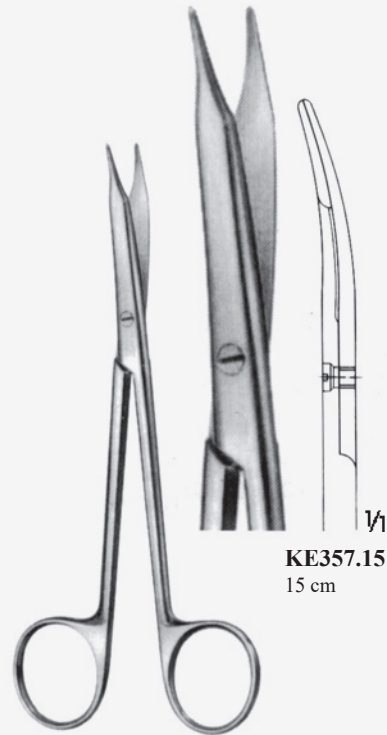

REYNOLDS
Eğri/Curved

KE357.15
15 cm

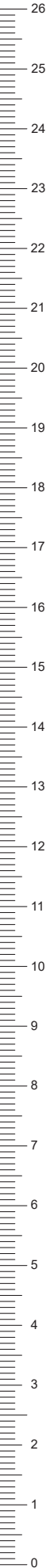
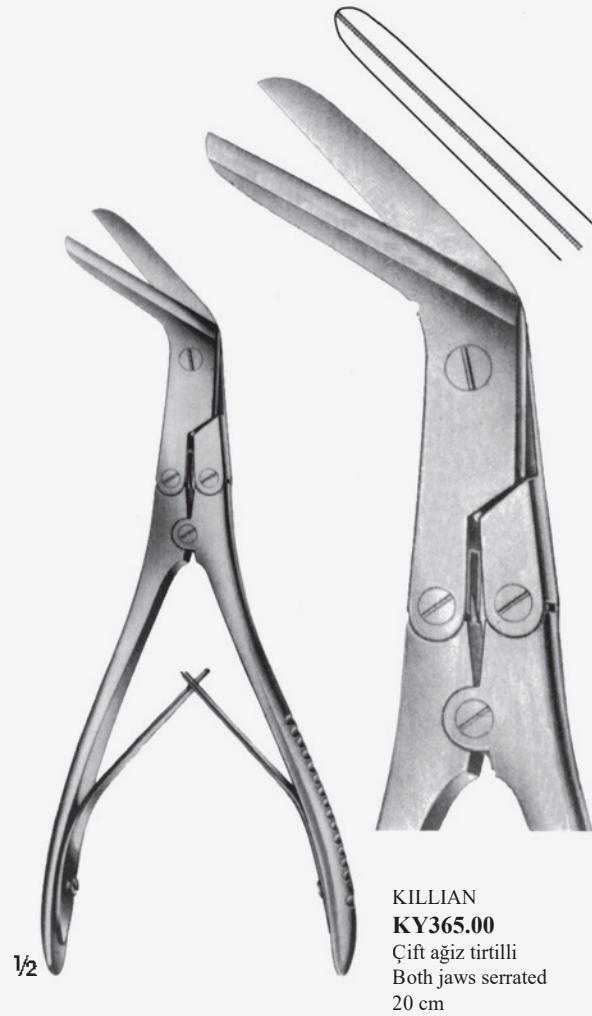
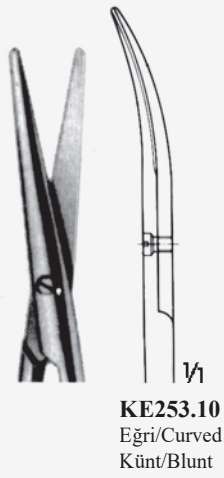

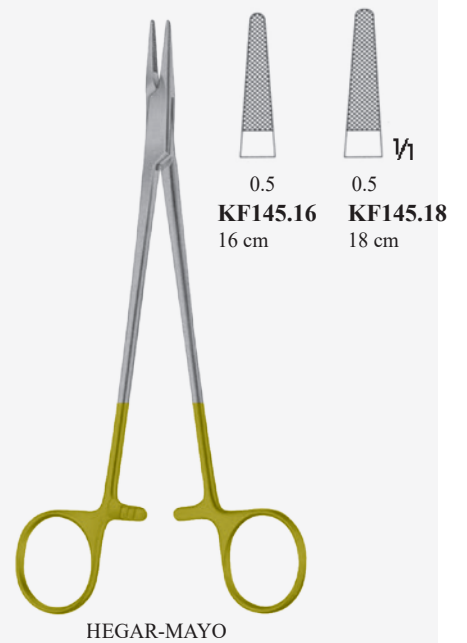
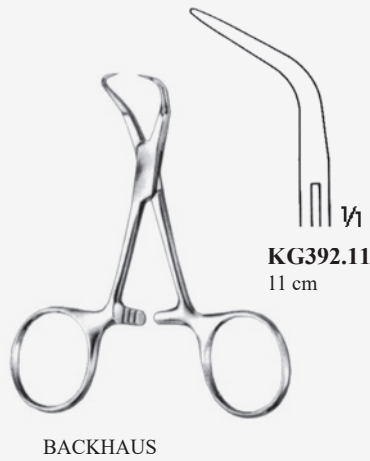
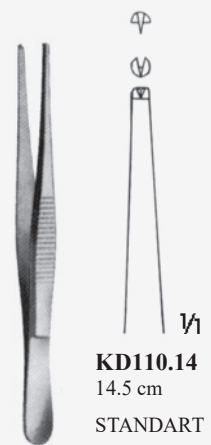
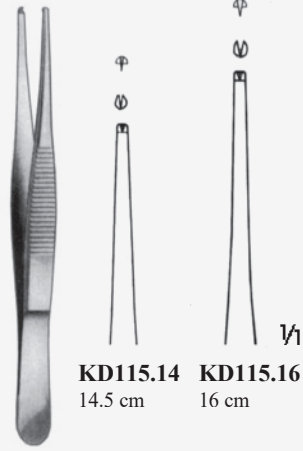
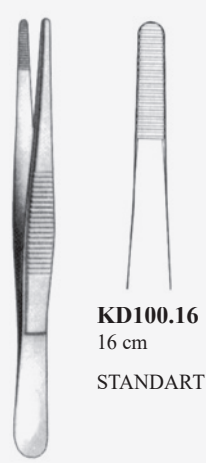

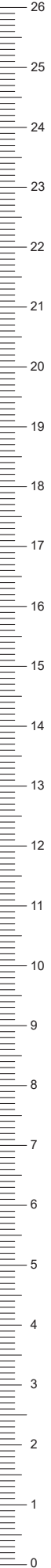

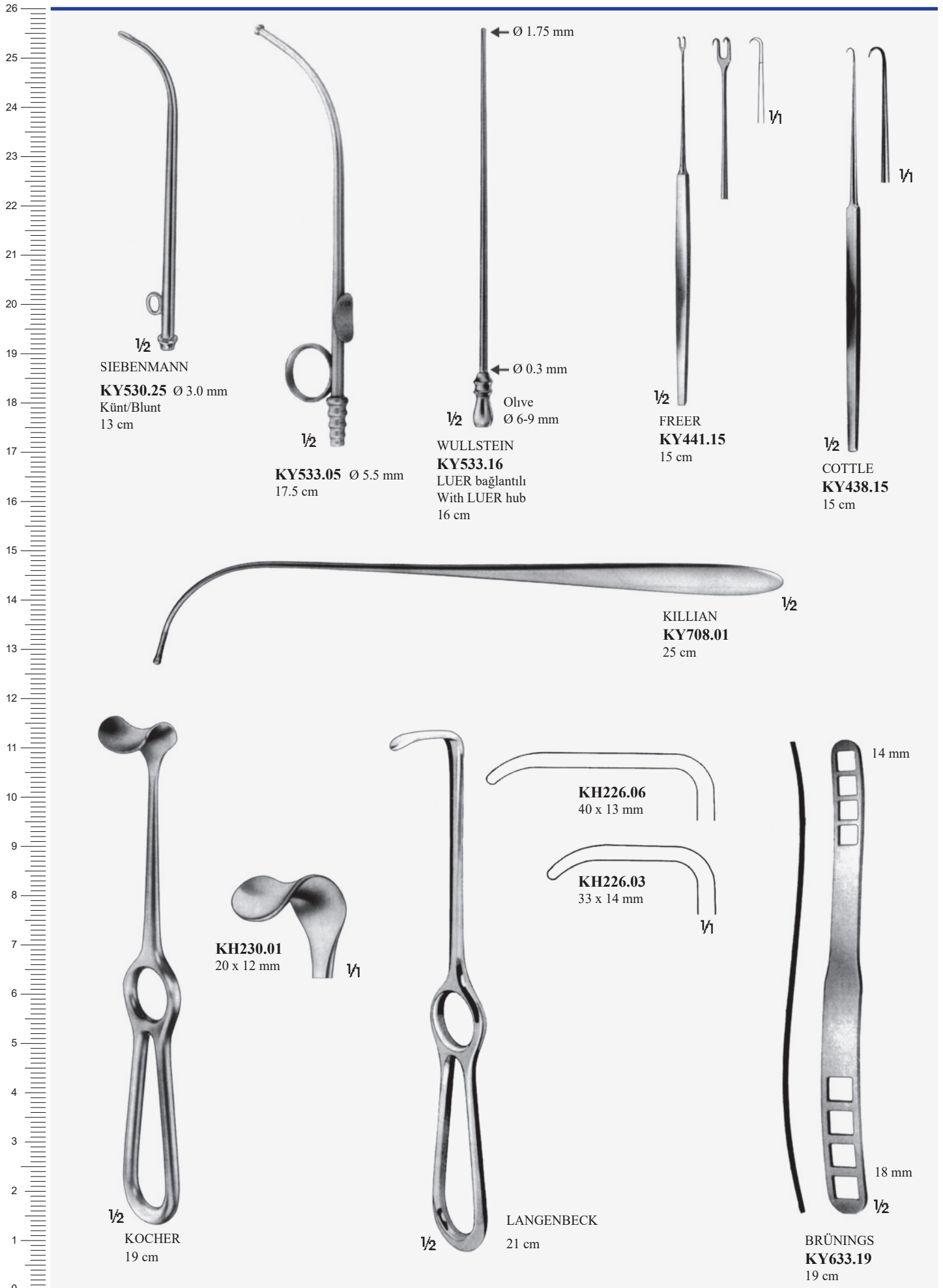

1/2
SIEBENMANN
KY530.25 Ø 3.0 mm
Künt/Blunt
13 cm

1/2
KY533.05 Ø 5.5 mm
17.5 cm

1/2
WULLSTEIN
KY533.16
LUER bağlantılı
With LUER hub
16 cm

1/2
FREER
KY441.15
15 cm

1/2
COTTLE
KY438.15
15 cm

1/2
KILLIAN
KY708.01
25 cm

KH230.01
20 x 12 mm
1/1

KH226.06
40 x 13 mm

KH226.03
33 x 14 mm
1/1

1/2
KOCHER
19 cm

1/2
LANGENBECK
21 cm

14 mm
18 mm
1/2
BRÜNINGS
KY633.19
19 cm



1/2

COTTLE
15 cm

KY319.02
50 x 7 mm



KY319.03
75 x 7 mm



KY319.04
90 x 7 mm



1/1

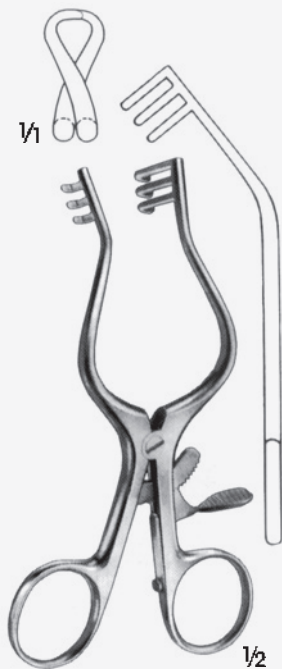

1/1

1/2

WULLSTEIN
KI123.13 Künt/Blunt
13 cm



1/2

ADSON-BABY
KI136.13 Künt/Blunt
13 cm



1/1

1/2



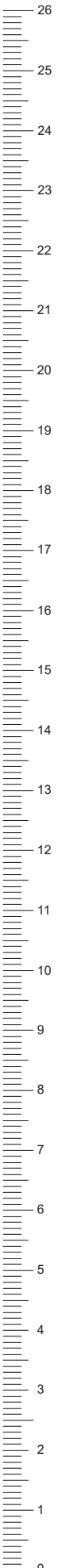

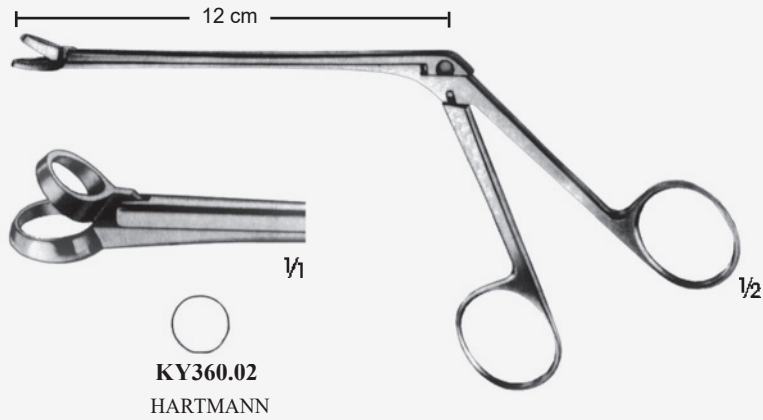
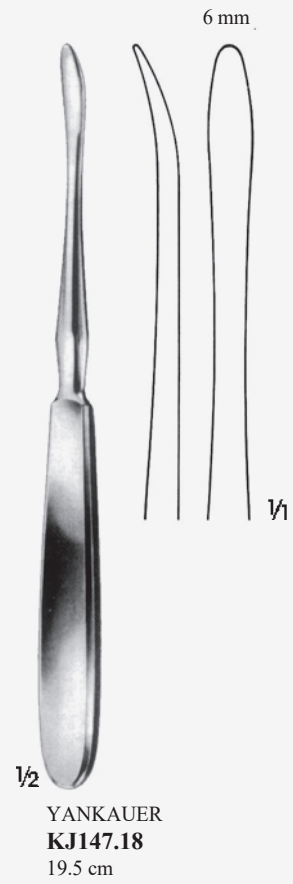
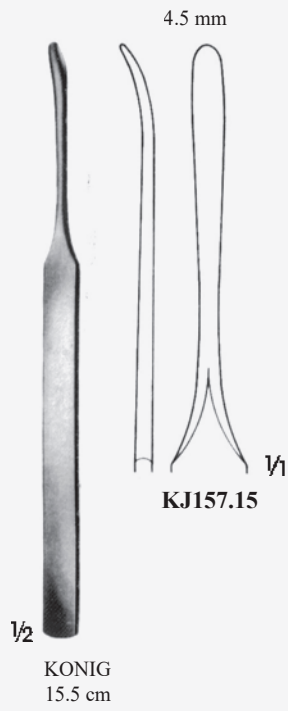
FREER
KY388.18 Sivri/Sharp
Künt/Blunt
18.5 cm



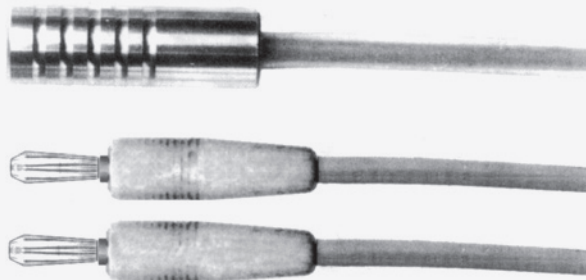

KP202.00
Bipolar kordon
Bipolar cord
2 mt.



- 0.4 mm 
- 0.7 mm 
- 1.0 mm 
- 1.3 mm 



STERILE CONTAINER
KC310.13
1/2 Size Container
285 x 280 x 135 mm

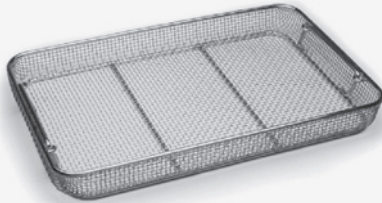

WIRE BASKET
KC390.03 For Sterile Container
Wire Baskets
255 x 245 x 30 mm

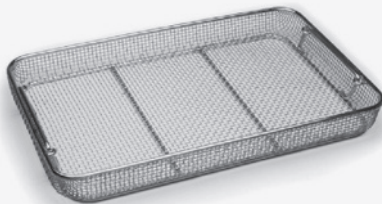

WIRE BASKET
KC390.07 For Sterile Container
Wire Baskets
255 x 245 x 70 mm



KP100.11 1.3 mm
17.5 cm



KP109.01 0.8 mm
20 cm
Izoleli/Insulated

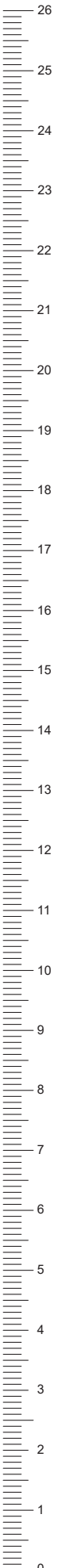

Mikro Cerrahi Seti

Micro Surgery Set



 **KARAOĞLU**[®]



| No | Quantity | Code | Description |
|----|----------|-----------------|--|
| 1 | 1 | KA170.00 | Instrument for Measuring, 15 cm |
| 2 | 1 | KA104.13 | Scalpel Handle, 13.5 cm |
| 3 | 2 | KZ309.10 | Micro Scissors, Curved, 12 cm |
| 4 | 1 | KE475.12 | Micro Scissors, Curved, 12 cm |
| 5 | 1 | KE476.12 | Micro Scissors, Straight, 12 cm |
| 6 | 1 | KE481.16 | Micro Scissors, Curved, 16 cm |
| 7 | 1 | KE222.09 | Delicate Scissors, Straight, 9 cm |
| 8 | 1 | KE315.14 | Delicate Scissors Curved, 14.5 cm |
| 9 | 1 | KD164.04 | Micro Suture Tying Forcep, 11.5 cm |
| 10 | 1 | KD166.06 | Micro Suture Tying Forcep, 11.5 cm |
| 11 | 2 | KD163.03 | Micro Suture Tying Forcep, 11.5 cm |
| 12 | 1 | KD263.09 | Micro Suture Tying Forcep, 1x2 teeth 0.2 mm 9.5 cm |
| 13 | 1 | KD266.14 | Austin Micro Suture Tying Forcep, 0.8 mm 14 cm |
| 14 | 1 | KD139.12 | Micro-Adson Delicate Dissecting Forcep, 12 cm |
| 15 | 1 | KD140.12 | Adson Delicate Dissecting Forcep, 12 cm |
| 16 | 1 | KD152.00 | Adson Delicate Tissue Forcep, 12 cm |
| 17 | 1 | KF309.12 | Micro Needle Holder, With Catch, 12 cm |
| 18 | 1 | KF302.15 | Micro Needle Holder, Without Catch, 15 cm |
| 19 | 1 | KH105.15 | Kilner Skin Hook, 15 cm |
| 20 | 1 | KI136.13 | Adson-Baby Self-Retaining Retractor, Blunt, 13 cm |
| 21 | 1 | KG100.02 | Biemer-Muller Approximator, Jaw 4.5 mm, Opening 3 mm, Closing Force 25-30 gr |
| 22 | 1 | KG105.00 | Approximator complete, with key |
| 23 | 3 | KG100.00 | Approximator |
| 24 | 2 | KG104.14 | Biemer Vessel Clip, 14.5 cm |
| 25 | 1 | KC310.08 | Flat Container, 285 x 280 x 85 mm |
| 26 | 1 | KC390.03 | Wire Baskets, 255 x 245 x 30 mm |
| 27 | 1 | KC851.00 | Silicon mat 245 X 245 mm |



1



2



3



4



5



6



7



8



9



10



11



12



13



14



15



16



17



18



19



20



21



22



23



24



25

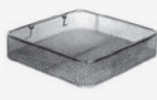

26

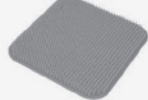

27

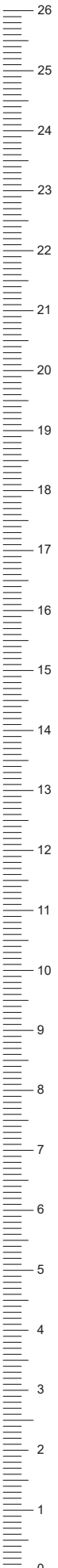

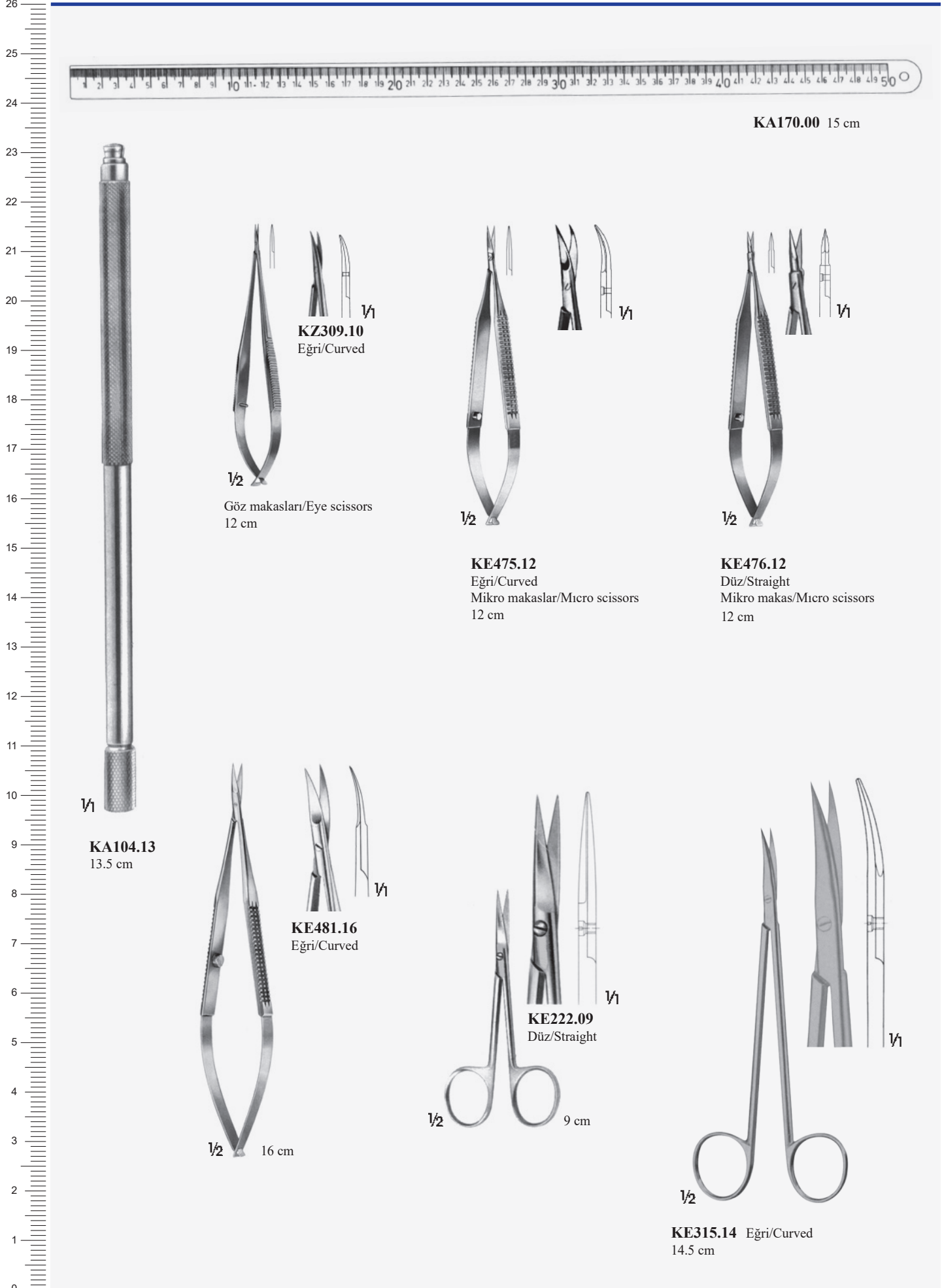

KA170.00 15 cm

KZ309.10
Eğri/Curved

$\frac{1}{2}$
Göz makasları/Eye scissors
12 cm

KE475.12
Eğri/Curved
Mikro makaslar/Micro scissors
12 cm

KE476.12
Düz/Straight
Mikro makas/Micro scissors
12 cm

$\frac{1}{1}$
KA104.13
13.5 cm

KE481.16
Eğri/Curved

$\frac{1}{2}$ 16 cm

$\frac{1}{2}$ **KE222.09**
Düz/Straight
9 cm

$\frac{1}{2}$ **KE315.14** Eğri/Curved
14.5 cm



$\frac{1}{2}$
KD164.04
11.5 cm



$\frac{1}{2}$
KD166.06
11.5 cm



$\frac{1}{2}$
KD163.03
11.5 cm



$\frac{1}{2}$
BONNER MODELL
KD263.09
1 x 2 dişli platform
With plateau 1 x 2 teeth
9.5 cm

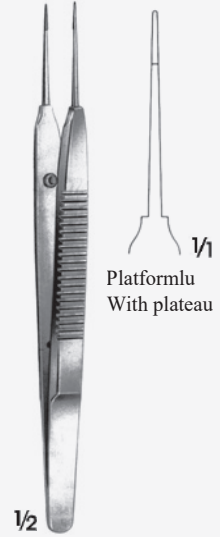

$\frac{1}{2}$
AUSTIN
KD266.14
14 cm



$\frac{1}{2}$
MICRO-ADSON
KD139.12
12 cm

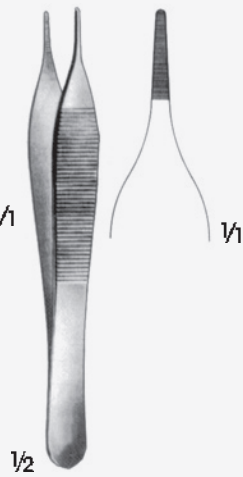

$\frac{1}{2}$
ADSON
KD140.12
12 cm



$\frac{1}{2}$
ADSON
KD152.00
Hassas doku penseti
Delicate tissue forceps
12 cm



$\frac{1}{2}$
Kilitli/With catch
12 cm



$\frac{1}{2}$
BARRAQUER
Kilitsiz/Without catch
15 cm

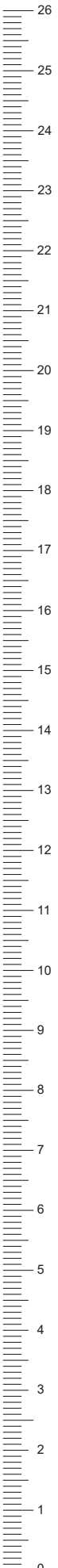

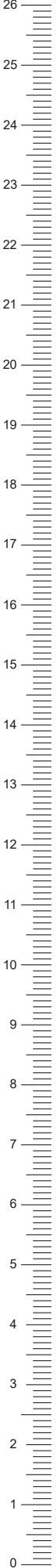

1/2
KILNER
KH105.15
16 cm



BIEMER-MULLER
KG100.02
Çene uzunluğu/Lenght of jaws. 4.5 mm
Açıklık/Opening 3 mm
Kapanma Kuvveti/Closing force 25-30 gr.



BIEMER
KG105.00
Komple Aproksimatör,
anahtarı ile



1/2
ADSON-BABY
KH136.13 Künt/Blunt
13 cm

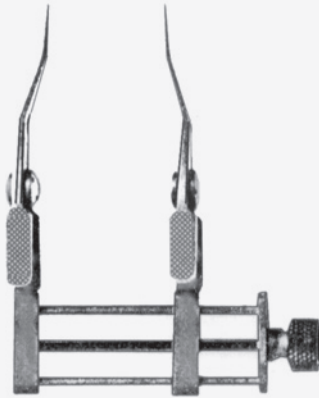

KG100.00
Aproksimatör/Approximator



VI
BIEMER
KG104.14
Kilitsiz/Without lock



STERILE CONTAINER
KC310.08
Flat Container
285 x 280 x 85 mm



WIRE BASKET
KC390.03 For Sterile Container
Wire Baskets
255 x 245 x 30 mm



SILICONE MAT
KC851.00 For Sterile Container
Silicone Mat
245 x 245 mm

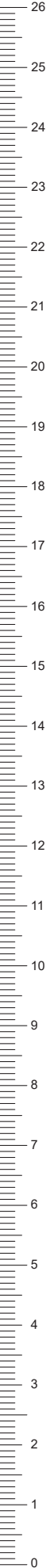



KARAOĞLU CERRAHİ ALETLER

İstiklal Mah. İlkadım Sanayi Sitesi 58.Sok. No:77
TEKKEKÖY/SAMSUN

Tel : 0555 013 61 05 - (0362) 238 61 04 - Fax : (0362) 238 55 91

info@karaoglucerrahi.com.tr

www.karaoglucerrahi.com.tr